



KD-R995BTS / KD-R990BTS / KD-R895BTS / KD-R792BT / KD-R790BT / KD-RD99BTS / KD-RD79BT / KD-R99MBS

CD RECEIVER

INSTRUCTION MANUAL

JVCKENWOOD Corporation



CONTENTS

BEFORE USE	2
BASICS	3
GETTING STARTED	4
1 Cancel the demonstration	
2 Set the clock and date	
3 Set the basic settings	
RADIO	5
CD/USB/iPod/ANDROID	8
Pandora®	10
iHeartRadio®	11
Spotify	12
SiriusXM® Radio	13
BLUETOOTH®	16
AUX	24
AUDIO SETTINGS	24
DISPLAY SETTINGS	29
LEARNING STEERING REMOTE CONTROL	31
REFERENCES	32
Maintenance	
More information	
TROUBLESHOOTING	36
SPECIFICATIONS	39
INSTALLATION/ CONNECTION	40

BEFORE USE

IMPORTANT

- To ensure proper use, please read through this manual before using this product. It is especially important that you read and observe Warning and Caution in this manual.
- Please keep the manual in a safe and accessible place for future reference.

▲ WARNING

- **Do not operate any function that takes your attention away from safe driving.**
- **Do not ingest the battery, Chemical Burn Hazard**

The remote control supplied with this product contains a coin/button cell battery.

If the coin/button cell battery is swallowed, it can cause severe internal burns in just 2 hours and can lead to death.

Keep new and used batteries away from children.

If the battery compartment does not close securely, stop using the product and keep it away from children.

If you think batteries might have been swallowed or placed inside any part of the body, seek immediate medical attention.

▲ Caution

Volume setting:

- Adjust the volume so that you can hear sounds outside the car to prevent accidents.
- Lower the volume before playing digital sources to avoid damaging the speakers by the sudden increase of the output level.

General:

- Avoid using the external device if it might hinder safe driving.
- Make sure all important data has been backed up. We shall bear no responsibility for any loss of recorded data.
- Never put or leave any metallic objects (such as coins or metal tools) inside the unit to prevent a short circuit.
- If a disc error occurs due to condensation on the laser lens, eject the disc and wait for the moisture to evaporate.
- Depending on the types of cars, the antenna will automatically extend when you turn on the unit with the antenna control wire connected (➔ 42). Turn off the unit when parking at a low ceiling area.

Remote control (RM-RK52):

- Do not leave the remote control in hot places such as on the dashboard.
- The Lithium battery is in danger of explosion if replaced incorrectly. Replace it only with the same or equivalent type.
- The battery pack or batteries shall not be exposed to excessive heat such as sunshine, fire or the like.

How to read this manual

- Operations are explained mainly using buttons on the faceplate of **KD-R995BTS**.
- English indications are used for the purpose of explanation. You can select the display language from the menu. (➔ 5)
- [XX] indicates the selected items.
- (➔ XX) indicates references are available on the stated page.

BASICS

Faceplate

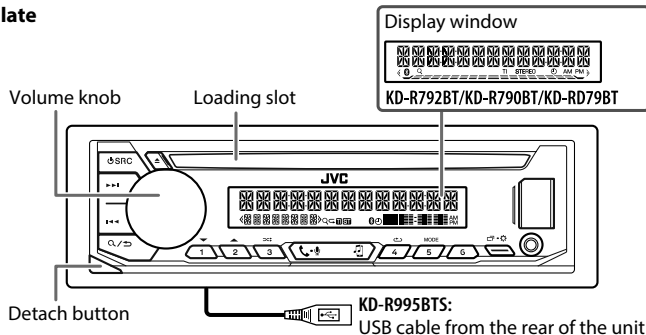

Attach

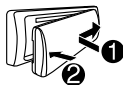

Detach

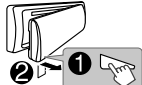

How to reset



Reset the unit within 5 seconds after detaching the faceplate.

To

On the faceplate

Turn on the power

- Press **SRC**.
- Press and hold to turn off the power.

Adjust the volume

Turn the volume knob.

- Press the volume knob to mute the sound or pause playback.
- Press again to cancel. The volume level returns to the previous level before muting or pause.

Select a source

- Press **SRC** repeatedly.
- Press **SRC**, then turn the volume knob within 2 seconds.

Change the display information

Press **DISP** repeatedly. (→ 34, 35)

Remote control (RM-RK52) (supplied for KD-R792BT)

Other models can be remotely controlled with an optionally purchased remote control.

Remote sensor (Do not expose to bright sunlight.)



Pull out the insulation sheet when using for the first time.



How to replace the battery



On the remote control

(Not available)

Press **VOL +** or **VOL -**.

- Press and hold **VOL +** to continuously increase the volume to 15.

Press **MUTE** to mute the sound or pause playback.

- Press again to cancel. The volume level returns to the previous level before muting or pause.

Press **SOURCE** repeatedly.

(Not available)

GETTING STARTED

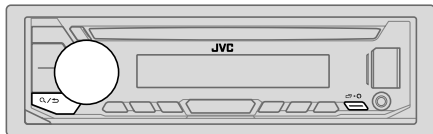

1 Cancel the demonstration

When you turn on the power for the first time (or [FACTORY RESET] is set to [YES], ➔ 5), the display shows: "CANCEL DEMO" ➔ "PRESS" ➔ "VOLUME KNOB"

- 1 Press the volume knob.
[YES] is selected for the initial setup.
- 2 Press the volume knob again.
"DEMO OFF" appears.

2 Set the clock and date

- 1 Press and hold .
 - 2 Turn the volume knob to select [CLOCK], then press the knob.
- To adjust the clock
- 3 Turn the volume knob to select [CLOCK ADJUST], then press the knob.
 - 4 Turn the volume knob to make the settings, then press the knob.
Hour ➔ Minute
 - 5 Turn the volume knob to select [CLOCK FORMAT], then press the knob.
 - 6 Turn the volume knob to select [12H] or [24H], then press the knob.

To set the date

- 7 Turn the volume knob to select [DATE SET], then press the knob.
- 8 Turn the volume knob to make the settings, then press the knob.
Day ➔ Month ➔ Year
- 9 Press to exit.

To return to the previous setting item, press / .

3 Set the basic settings

- 1 Press and hold .
- 2 Turn the volume knob to select an item (see the following table), then press the knob.
- 3 Repeat step 2 until the desired item is selected or activated.
- 4 Press to exit.

To return to the previous setting item, press / .

Default: **XX**

SYSTEM	
KEY BEEP	(Not applicable when 3-way crossover is selected.) ON: Activates the keypress tone. ; OFF: Deactivates.
SOURCE SELECT	
AM SRC*	ON: Enables AM in source selection. ; OFF: Disables. (➔ 5)
PANDORA SRC*	ON: Enables PANDORA FRONT/PANDORA REAR/PANDORA in source selection. ; OFF: Disables. (➔ 10)
IHEART SRC*	ON: Enables IHEARTRADIO-F/IHEARTRADIO-R/IHEARTRADIO in source selection. ; OFF: Disables. (➔ 11)
SPOTIFY SRC*	ON: Enables SPOTIFY FRONT/SPOTIFY REAR/SPOTIFY in source selection. ; OFF: Disables. (➔ 12)
BUILT-IN AUX*	ON: Enables AUX in source selection. ; OFF: Disables. (➔ 24)
USER S. REMO	(for KD-R792BT) See page 31 for details.

* Not displayed when the corresponding source is selected.

GETTING STARTED

F/W UPDATE

UPDATE SYSTEM

F/W UP xxxx	YES: Starts upgrading the firmware. ; NO: Cancels (upgrading is not activated).
----------------	--

FACTORY RESET	YES: Resets the settings to default (except the stored station). ; NO: Cancels.
--------------------------	---

CLOCK

TIME SYNC	ON: The clock time is automatically set using the Clock Time (CT) data in FM Radio Broadcast Data System signal/FM Radio Data System signal. ; OFF: Cancels.
------------------	--

CLOCK DISPLAY	ON: The clock time is shown on the display even when the unit is turned off. ; OFF: Cancels.
--------------------------	--

ENGLISH	Select the display language for menu and music information if applicable.
ESPANOL	By default, ENGLISH is selected.

RADIO

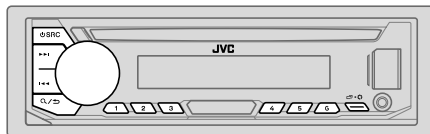

“ST” or “STEREO” lights up when receiving an FM stereo broadcast with sufficient signal strength.

Search for a station

- 1 Press **SRC** repeatedly to select FM or AM.
- 2 Press **◀▶** (or press **◀▶** on the remote control) to search for a station automatically.
(or)
Press and hold **◀▶** (or press and hold **◀▶** on the remote control) until “M” flashes, then press repeatedly to search for a station manually.

Settings in memory

You can store up to 18 stations for FM and 6 stations for AM.

Store a station

While listening to a station....

Press and hold one of the number buttons (1 to 6).
(or)

- 1 Press and hold the volume knob until “PRESET MODE” flashes.
- 2 Turn the volume knob to select a preset number, then press the knob.
The preset number flashes and “MEMORY” appears.

Select a stored station

Press one of the number buttons (1 to 6).
(or)

- 1 Press **Q/▷**.
- 2 Turn the volume knob to select a preset number, then press the knob.

RADIO

Other settings

- 1 Press and hold .
- 2 Turn the volume knob to select an item (see the following table), then press the knob.
- 3 Repeat step 2 until the desired item is selected/activated or follow the instructions stated on the selected item.
- 4 Press to exit.

To return to the previous setting item, press / .

Default: **XX**

TUNER SETTING (except KD-R792BT)

RADIO TIMER

Turns on the radio at a specific time regardless of the current source.

- 1 **ONCE/DAILY/WEEKLY/OFF**: Select how often the timer will be turned on.
- 2 **FM/AM/SIRIUS XM***1: Select the source.
- 3 **01 to 18** (for FM/SIRIUS XM)/**01 to 06** (for AM): Select the preset station.
- 4 Set the activation day*2 and time.
“” lights up when complete.

Radio Timer will not activate for the following cases.

- The unit is turned off.
- **[OFF]** is selected for **[AM SRC]** in **[SOURCE SELECT]** after Radio Timer for AM is selected. (→ 4)

SSM

SSM 01–06 / SSM 07–12 / SSM 13–18: Automatically presets up to 18 stations for FM. “SSM” stops flashing when the first 6 stations are stored. Select **SSM 07–12 / SSM 13–18** to store the following 12 stations.

IF BAND

AUTO: Increases the tuner selectivity to reduce interference noises from adjacent FM stations. (Stereo effect may be lost.) ; **WIDE**: Subjects to interference noises from adjacent FM stations, but sound quality will not be degraded and the stereo effect will remain.

MONO SET

ON: Improves the FM reception, but the stereo effect will be lost. ;
OFF: Cancels.

AREA

N.AMERICA: For North/Central/South America, AM/FM intervals: 10 kHz/200 kHz. ; **S.AMERICA**: For some South American countries, AM/FM intervals: 10 kHz/50 kHz. ; **EUROPE**: For any other areas, AM/FM intervals: 9 kHz/50 kHz.

PTY SEARCH*3

Select a PTY code (see below).

If there is a station broadcasting a program of the same PTY code as you have selected, that station is tuned in.

*1 **KD-R995BTS/KD-R990BTS/KD-R895BTS/KD-RD99BTS/KD-R99MBS**: Selectable only when SiriusXM Vehicle Tuner is connected. (→ 13)

*2 Selectable only when **[ONCE]** or **[WEEKLY]** is selected in step 1.

*3 Only for FM source.

PTY code (except KD-R792BT)

NEWS, INFORM (information), **SPORTS, TALK, ROCK, CLS ROCK** (classic rock), **ADLT HIT** (adult hits), **SOFT RCK** (softrock), **TOP 40, COUNTRY, OLDIES, SOFT, NOSTALGA** (nostalgia), **JAZZ, CLASSICL** (classical), **R & B** (rhythm and blues), **SOFT R&B** (soft rhythm and blues), **LANGUAGE, REL MUSC** (religious music), **REL TALK** (religious talk), **PERSNLTY** (personality), **PUBLIC, COLLEGE, HABL ESP** (Spanish talk), **MUSC ESP** (Spanish music), **HIP HOP, WEATHER**

RADIO

Default: **XX**

TUNER SETTING (for KD-R792BT)	
RADIO TIMER	<p>Turns on the radio at a specific time regardless of the current source.</p> <p>1 ONCE/DAILY/WEEKLY/OFF: Select how often the timer will be turned on.</p> <p>2 FM/AM: Select the band.</p> <p>3 01 to 18 (for FM)/01 to 06 (for AM): Select the preset station.</p> <p>4 Set the activation day*¹ and time.</p> <p>“Ⓞ” lights up when complete.</p> <p>Radio Timer will not activate for the following cases.</p> <ul style="list-style-type: none"> • The unit is turned off. • [OFF] is selected for [AM SRC] in [SOURCE SELECT] after Radio Timer for AM is selected. (➔ 4)
SSM	<p>SSM 01–06/SSM 07–12/SSM 13–18: Automatically presets up to 18 stations for FM. “SSM” stops flashing when the first 6 stations are stored. Select SSM 07–12/SSM 13–18 to store the following 12 stations.</p>
IF BAND	<p>AUTO: Increases the tuner selectivity to reduce interference noises from adjacent FM stations. (Stereo effect may be lost.) ; WIDE: Subjects to interference noises from adjacent FM stations, but sound quality will not be degraded and the stereo effect will remain.</p>
MONO SET	<p>ON: Improves the FM reception, but the stereo effect will be lost. ;</p> <p>OFF: Cancels.</p>
NEWS SET*²	<p>ON: The unit will temporarily switch to News Programme if available. ;</p> <p>OFF: Cancels.</p>
REGIONAL*²	<p>ON: Switches to another station only in the specific region using the “AF” control. ; OFF: Cancels.</p>
AF SET*²	<p>ON: Automatically searches for another station broadcasting the same program in the same Radio Data System network with better reception when the current reception is poor. ; OFF: Cancels.</p>

TI	<p>ON: Allows the unit to temporarily switch to Traffic Information if available (“TI” lights up) while listening to all sources except in AM. ; OFF: Cancels.</p>
AREA	<p>N.AMERICA: For North/Central/South America, AM/FM intervals: 10 kHz/200 kHz. ; S.AMERICA: For some South American countries, AM/FM intervals: 10 kHz/50 kHz. ; EUROPE: For any other areas, AM/FM intervals: 9 kHz/50 kHz.</p>
PTY SEARCH*²	<p>Select a PTY code (see below).</p> <p>If there is a station broadcasting a program of the same PTY code as you have selected, that station is tuned in.</p>

*¹ Selectable only when [ONCE] or [WEEKLY] is selected in step **1**.

*² Only for FM source.

PTY code (for KD-R792BT)

NEWS, AFFAIRS, INFO, SPORT, EDUCATE, DRAMA, CULTURE, SCIENCE, VARIED, POP M (music), ROCK M (music), EASY M (music), LIGHT M (music), CLASSICS, OTHER M (music), WEATHER, FINANCE, CHILDREN, SOCIAL, RELIGION, PHONE IN, TRAVEL, LEISURE, JAZZ, COUNTRY, NATION M (music), OLDIES, FOLK M (music), DOCUMENT

CD/USB/iPod/ANDROID

Start playback

The source changes automatically and playback starts.

CD

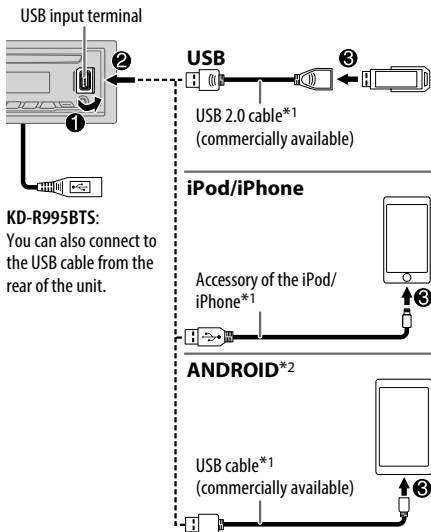
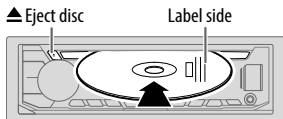

KD-R995BTS:
You can also connect to the USB cable from the rear of the unit.

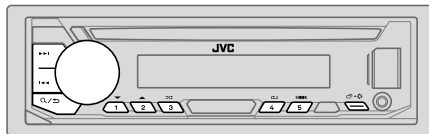

Selectable source:

- **KD-R995BTS:** CD/USB FRONT/USB REAR/iPod FRONT/iPod REAR/ANDROID FRONT/ANDROID REAR
- **KD-R990BTS/KD-R895BTS/KD-R792BT/KD-R790BT/KD-RD99BTS/KD-RD79BT/KD-R99MBS:** CD/USB/iPod USB/ANDROID

To	On the faceplate	On the remote control
Reverse/Fast-forward*3	Press and hold ◀◀ / ▶▶ .	Press and hold ◀ / ▶ .
Select a track/file	Press ◀◀ / ▶▶ .	Press ◀ / ▶ .
Select a folder*4	Press 2 ▲ / 1 ▼ .	Press ▲ / ▼ .
Repeat play*5	Press 4 ↺ repeatedly. TRACK REPEAT/ALL REPEAT : Audio CD TRACK REPEAT/FOLDER REPEAT/ALL REPEAT : MP3/WMA/AAC/WAV/ FLAC file	ONE REPEAT/ALL REPEAT/REPEAT OFF : iPod or ANDROID
Random play*5	Press 3 ↻ repeatedly. ALL RANDOM/RANDOM OFF : Audio CD FOLDER RANDOM/ALL RANDOM/RANDOM OFF : MP3/WMA/AAC/WAV/ FLAC file SONG RANDOM/ALL RANDOM/RANDOM OFF : iPod or ANDROID	

*1 Do not leave the cable inside the car when not using.

*2 When connecting an Android device, "Press [VIEW] to install JVC MUSIC PLAY APP" is shown. Follow the instructions to install the application. You can also install the latest version of JVC MUSIC PLAY application on your Android device before connecting.

*3 For ANDROID: Applicable only when [AUTO MODE] is selected. (→ 9)

*4 For CD: Only for MP3/WMA/AAC files. This does not work for iPod/ANDROID.

*5 For iPod/ANDROID: Applicable only when [HEAD MODE]/[AUTO MODE] is selected. (→ 9)

CD/USB/iPod/ANDROID

Select control mode

While in iPod FRONT/iPod REAR/iPod USB source, press **5 MODE** repeatedly.

HEAD MODE: Control iPod from this unit.

IPHONE MODE: Control iPod using the iPod itself. However, you can still play/pause or file skip from this unit.

While in ANDROID FRONT/ANDROID REAR/ANDROID source, press **5 MODE** repeatedly.

AUTO MODE: Control Android device from this unit via JVC MUSIC PLAY application installed in the Android device.

AUDIO MODE: Control Android device using the Android device itself via other media player applications installed in the Android device. However, you can still play/pause or file skip from this unit.

Select music drive

While in USB FRONT/USB REAR/USB source, press **5 MODE** repeatedly.

Stored songs in the following drive will be played back.

- Selected internal or external memory of a smartphone (Mass Storage Class).
- Selected drive of a multiple drives device.

Settings to use JVC Remote application

JVC Remote application is designed to control the JVC car receiver's operations from the iPhone/iPod (via USB input terminal).

Preparation:

Install the latest version of JVC Remote application on your device before connecting.

You can make the settings in the same way as connection via Bluetooth. (→ 22)

Select a file from a folder/list

For iPod/ANDROID, applicable only when [HEAD MODE]/[AUTO MODE] is selected.

- 1 Press **Q / ↵**.
- 2 Turn the volume knob to select a folder/list, then press the knob.
- 3 Turn the volume knob to select a file, then press the knob.

Quick search (applicable only for CD, USB FRONT, USB REAR, USB, ANDROID FRONT, ANDROID REAR and ANDROID source)

If you have many files, you can search through them quickly.

Turn the volume knob quickly to browse through the list quickly.

Alphabet search (applicable only for iPod FRONT, iPod REAR, iPod USB, ANDROID FRONT, ANDROID REAR and ANDROID source)

You can search for a file according to the first character.

For iPod FRONT/iPod REAR/iPod USB source

Press **2 ▲ / 1 ▼** or turn the volume knob quickly to select the desired character (A to Z, 0 to 9, OTHERS).

- Select "OTHERS" if the first character is other than A to Z, 0 to 9.

For ANDROID FRONT/ANDROID REAR/ANDROID source

1 Press 2 ▲ / 1 ▼ to enter character search.

2 Turn the volume knob to select the desired character.

^A^: Upper case letters (A to Z)

A: Lower case letters (a to z)

-0-: Numbers (0 to 9)

-OTHERS-: Character other than A to Z, 0 to 9

3 Press the volume knob to start searching.

- To return to the previous setting item, press **Q / ↵**.
- To cancel, press and hold **Q / ↵**.

Pandora® (except KD-R792BT)

Preparation:

Install the latest version of the Pandora application on your device (iPhone/iPod touch), then create an account and log in to Pandora.

- Select [ON] for [PANDORA SRC] in [SOURCE SELECT]. (→ 4)



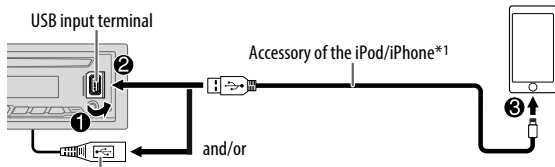

Start listening

- 1 Open the Pandora application on your device.
- 2 Connect your device to the USB input terminal.



KD-R995BTS: You can also connect to the USB cable from the rear of the unit.

- 3 Press **SRC** repeatedly to select PANDORA FRONT/PANDORA REAR/PANDORA.
Broadcast starts automatically.

To	On the faceplate	On the remote control
Playback/pause	Press the volume knob.	Press  .
Skip a track	Press  .	Press  .
Thumbs up or thumbs down*2	Press 2 ▲ / 1 ▼ .	Press  /  .

*1 Do not leave the cable inside the car when not using.

*2 If thumbs down is selected, the current track is skipped.

Create and store a new station

- 1 Press **Q / ↵**.
- 2 Turn the volume knob to select [NEW STATION], then press the knob.
- 3 Turn the volume knob to select [FROM TRACK] or [FROM ARTIST], then press the knob.
A new station is created based on the current song or artist.
- 4 Press and hold one of the number buttons (**3, 4, 5 or 6**) to store.

To select a stored station: Press one of the number buttons (**3, 4, 5 or 6**).

Search for a registered station

- 1 Press **Q / ↵**.
- 2 Turn the volume knob to select an item, then press the knob.
[BY DATE]: According to the registered date
[A-Z]: By alphabetical order
- 3 Turn the volume knob to select the desired station, then press the knob.

To cancel, press and hold **Q / ↵**.

Bookmark current song information

Press and hold the volume knob.

"BOOKMARKED" appears and the information is stored to your device.

- The bookmark is available on your Pandora account but not on this unit.

iHeartRadio® (except KD-R792BT)

Preparation:

Install the latest version of iHeartAuto application on your device (iPhone/iPod touch), then create an account and log in to iHeartRadio.

- Select [ON] for [IHEART SRC] in [SOURCE SELECT]. (→ 4)

Start listening

- 1 Open the iHeartAuto application on your device.
- 2 Connect your device to the USB input terminal.

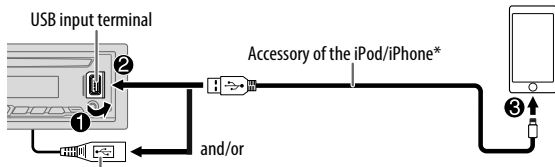

KD-R995BTS: You can also connect to the USB cable from the rear of the unit.

- 3 Press **SRC** repeatedly to select IHEARTRADIO-F/IHEARTRADIO-R/IHEARTRADIO.
Broadcast starts automatically

* Do not leave the cable inside the car when not using.

To	On the faceplate	On the remote control
Playback/pause	Press the volume knob.	Press X .
Skip a track for custom station	Press ▶▶ .	Press ▶ .
Thumbs up or thumbs down	Press 2 ▲ / 1 ▼ .	Press ▲ / ▼ .
Create a new/custom station	Press and hold the volume knob.	(Not available)
Scan for live station	<ol style="list-style-type: none">1 Press 3 to start scanning.2 Press 3 again to listen to the station.	(Not available)

Search and store a station

- 1 Press **Q / ↵**.
- 2 Turn the volume knob to select a category, then press the knob.
- 3 Turn the volume knob to select the desired station, then press the knob.
When a city list appears, you can search cities in alphabetical order by turning the volume knob quickly.

To cancel, press and hold **Q / ↵**.

To store a station: Press and hold one of the number buttons (**4**, **5** or **6**).

To select a stored station: Press one of the number buttons (**4**, **5** or **6**).

Spotify

Preparation:

Install the latest version of the Spotify application on your device (iPhone/iPod touch), then create an account and log in to Spotify.

- Select [ON] for [SPOTIFY SRC] in [SOURCE SELECT]. (➔ 4)

Start listening

- 1 Open the Spotify application on your device.
- 2 Connect your device to the USB input terminal.

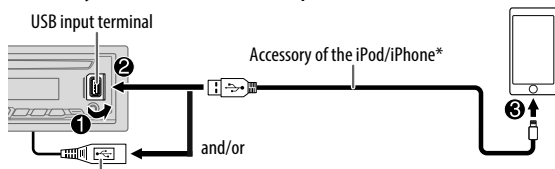

KD-R995BTS: You can also connect to the USB cable from the rear of the unit.

- 3 Press **SRC** repeatedly to select SPOTIFY FRONT/SPOTIFY REAR/SPOTIFY.

Broadcast starts automatically

* Do not leave the cable inside the car when not using.

To	On the faceplate	On the remote control
Playback/pause	Press the volume knob.	Press
Skip a track	Press *1 / .	Press *1 / .
Thumbs up or thumbs down*2	Press 2 ▲ / 1 ▼ .	Press / .
Start radio	Press and hold 5 .	(Not available)

To	On the faceplate	On the remote control
Repeat play*3	Press 4 repeatedly. ALL REPEAT, ONE REPEAT*1, REPEAT OFF	(Not available)
Random play*3	Press 3 repeatedly*1. ALL RANDOM, RANDOM OFF	(Not available)

*1 Available for premium account users only.

*2 This feature is available for tracks in Radio only. If thumbs down is selected, the current track is skipped.

*3 Available for tracks in Playlists only.

Save favorite song information

While listening to the Radio on Spotify...

Press and hold the volume knob.

"SAVED" appears and the information is stored to "Your Music" or "Your Library" on your Spotify account.

To unsave, repeat the same procedure.

"REMOVED" appears and the information is removed from "Your Music" or "Your Library" on your Spotify account.

Search for a song or station

- 1 Press **Q / ↵**.
- 2 Turn the volume knob to select a list type, then press the knob. The list types displayed differ depending on the information sent from Spotify.
- 3 Turn the volume knob to select the desired song or station, then press the knob. You can browse through the list quickly by turning the volume knob quickly.

To cancel, press and hold **Q / ↵**.

SiriusXM® Radio (for KD-R995BTS/KD-R990BTS/KD-R895BTS/KD-RD99BTS/KD-R99MBS)

Only SiriusXM® brings you more of what you love to listen to, all in one place. Get over 140 channels, including commercial-free music plus the best sports, news, talk, comedy and entertainment. Welcome to the world of satellite radio. A SiriusXM Vehicle Tuner and Subscription are required.

Preparation:

- 1 Connect the optional SiriusXM Vehicle Tuner (commercially available).

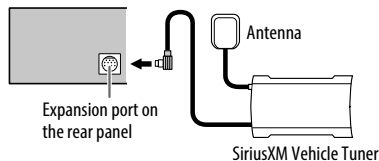

- 2 Check your Radio ID for activation.

The SiriusXM Radio ID is required for activation and can be found by tuning to Channel 0 as well as on the label found on the SiriusXM Vehicle Tuner and its packaging.

The Radio ID does not include the letters I, O, S or F.

- 3 Press **SRC** repeatedly to select SIRIUS XM to start updating.

Start listening

- 1 Press **SRC** repeatedly to select SIRIUS XM.
- 2 Press **Q** / **▷**.
"Q" lights up.
- 3 Turn the volume knob to select a CATEGORY, then press the knob.
- 4 Turn the volume knob to select a category from the list, then press the knob.
If "ALL CHANNEL" is selected, all the available channels will be shown.
- 5 Turn the volume knob to select a channel, then press the knob.
(or)
Press **◀◀** / **▶▶** to search for a channel manually.
• Pressing and holding **◀◀** / **▶▶** changes the channel rapidly.

If a locked channel or a mature channel is selected, a pass code input screen appears. Enter the pass code to receive the channel. (**→ 15**)

Settings in memory

You can store up to 18 channels.

Store a channel

While listening to a channel...

Press and hold one of the number buttons (**1 to 6**).

(or)

- 1 Press and hold the volume knob until "PRESET MODE" flashes.
- 2 Turn the volume knob to select a preset number, then press the knob.
The preset number flashes and "MEMORY" appears.

Select a stored channel

Press one of the number buttons (**1 to 6**).

(or)

- 1 Press **Q** / **▷**.
- 2 Turn the volume knob to select PRESET, then press the knob.
- 3 Turn the volume knob to select a preset number, then press the knob.

(or)

Press **▲** / **▼** on the remote control.

SiriusXM® Radio (for KD-R995BTS/KD-R990BTS/KD-R895BTS/KD-RD99BTS/KD-R99MBS)

SiriusXM Replay™

While listening to a channel....











1 Press the volume knob.

"⏸" lights up and the unit memorizes this paused position.

2 Press the volume knob to start Replay.

Replay starts from the paused position in step 1.

During Replay...

To	On the faceplate	On the remote control
Playback/pause	Press the volume knob.	Press  .
Skip backward/ forward	Press   .	Press   .
Rewind/Fast-forward	Press and hold   .	Press and hold   .
Go to Live and exit Replay	Press and hold the volume knob. 1 Press  2 Turn the volume knob to select LIVE, then press the knob.	Press and hold  .

SmartFavorites and TuneStart™

User preset channels are initially assigned as the SmartFavorites channels. SmartFavorite channel is available with SXV200 or later SiriusXM tuner models. The SiriusXM Vehicle Tuner automatically buffers the broadcast audio content of the SmartFavorites channels in the background.



Using SXV200: This unit can assign a maximum of 6 SmartFavorites channels. If you try to assign the 7th channel, an error beep tone will be heard. Initially, preset channels 1 to 6 are assigned as SmartFavorites.

Using SiriusXM tuner models later than SXV200: This unit can assign a maximum of 18 SmartFavorites channels. Initially, all preset channels are assigned as SmartFavorites.

- "*" appears at the last character of the channel name for the SmartFavorites channels.

When you select a SmartFavorite channel, you can rewind and replay up to 30 minutes of any of the missed news, talk, sports or music content.

- Playback starts from the beginning of the song if [TUNE START] is set to [ON] (➔ 15) for most music channels stored as a SmartFavorite.

To	On the faceplate
Select a stored SmartFavorite channel	Press one of the number buttons (1 to 6). 1 Press  2 Turn the volume knob to select PRESET, then press the knob. 3 Turn the volume knob to select a preset number, then press the knob.
Cancel SmartFavorites channels	1 Press  2 Turn the volume knob to select PRESET, then press the knob. 3 Turn the volume knob to select a preset number, then press and hold the knob. "*" is removed from the last character.
Reassign SmartFavorites channels	Repeat steps 1 to 3 of cancelling SmartFavorites channels. "*" appears at the last character.

SiriusXM® Radio (for KD-R995BTS/KD-R990BTS/KD-R895BTS/KD-RD99BTS/KD-R99MBS)

TuneScan™

You can get a short preview of the songs that you have missed on each of your SmartFavorites music channels or currently tuned music channel.

- 1 Press **Q** / **↵**.
- 2 Turn the volume knob to select **TUNE SCAN**, then press the knob. Scanning start for the first 6 seconds of the recorded music contents.
 - To listen to the current song, press the volume knob to stop scanning. The unit continues playing the current song.
 - To select the previous/next song, press **◀** / **▶**.
 - To cancel scanning, press and hold the volume knob. Playback returns to the channel before you entered TuneScan.

SiriusXM settings

- 1 Press and hold **☐** - **✱**.
- 2 Turn the volume knob to select an item (see the following table), then press the knob.
- 3 Repeat step 2 until the desired item is selected/activated or follow the instructions stated on the selected item.
- 4 Press **☐** - **✱** to exit.

To return to the previous setting item, press **Q** / **↵**.

Default: **XX**

SIRIUS XM

- | | |
|---------------------|---|
| CHANNEL LOCK | To unlock settings: <ol style="list-style-type: none">1 Turn the volume knob to select a number.2 Press ◀ / ▶ to move to the entry position.3 Repeat steps 1 and 2 to enter the current pass code. (Initial pass code is 0000.)4 Press the volume knob to confirm. |
|---------------------|---|

CODE SET	<ol style="list-style-type: none">1 Press the volume knob to enter [NEW CODE].2 Turn the volume knob to select a number.3 Press ◀ / ▶ to move to the entry position.4 Repeat steps 2 and 3 to enter a new 4-digit pass code.5 Press the volume knob to confirm.6 Repeat steps 2 to 5 to reconfirm the pass code.<ul style="list-style-type: none">• Make a note of the new pass code to enter channel lock settings for next time.
LOCK SETTING	MATURE CH: Selects the SiriusXM-defined lock setting. ; USER DEFINED: Selects the individual channels the user wants to lock. ; OFF: Cancels.
CHANNEL EDIT *1	<ol style="list-style-type: none">1 Turn the volume knob to select a category, then press the knob.2 Turn the volume knob to select a channel you want to lock, then press the knob. "L" appears in front of the channel number.3 Press and hold Q / ↵ to exit.
CHANNEL CLEAR *1	YES: Clears all the locked channels. ; NO: Cancels.
TUNE START *2	ON: All qualified music channels in the SmartFavorites will start playback from the beginning of the song. ; OFF: Cancels.
SIGNAL LEVEL	Shows the strength (NO SIGNAL/WEAK/GOOD/STRONG) of the current received signal.
BUFFER USAGE	Shows the memory usage (0% to 100%) for Replay buffer.
SXM RESET	YES: Resets stored channel and lock setting to default. ; NO: Cancels.

*1 Displayed only when **[USER DEFINED]** is selected.

*2 Available only if the connected SiriusXM Vehicle Tuner is SXV200 or later that supports SmartFavorites.

BLUETOOTH — Connection

Supported Bluetooth profiles

- Hands-Free Profile (HFP)
- Advanced Audio Distribution Profile (A2DP)
- Audio/Video Remote Control Profile (AVRCP)
- Serial Port Profile (SPP)
- Phonebook Access Profile (PBAP)

Supported Bluetooth codecs

- Sub Band Codec (SBC)
- Advanced Audio Coding (AAC)

Connect the microphone

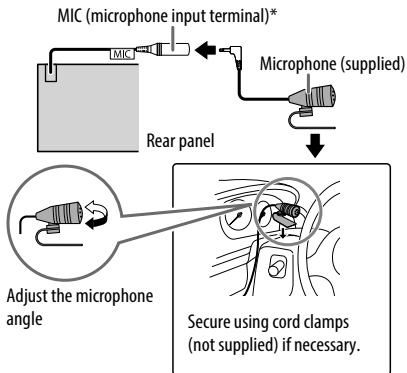

* For the location of the microphone input terminal/microphone input jack, refer to page “Connecting external amplifiers” on page 43.

Pair and connect a Bluetooth device for the first time

- 1 Press **ⓄSRC** to turn on the unit.
 - 2 Search and select “KD-R9**BTS”/“KD-R8**BTS”/“KD-R7**BT”/“KD-RD9*BTS”/“KD-RD7*BT”/“KD-R9*MBS” on the Bluetooth device.
“BT PAIRING” flashes on the display.
 - For some Bluetooth devices, you may need to enter the Personal Identification Number (PIN) code immediately after searching.
 - 3 Perform (A) or (B) depending on what appears on the display.
For some Bluetooth devices, pairing sequence may vary from the steps described below.
(A) “[Device Name]” → “XXXXXX” → “VOL – YES” → “BACK – NO”
“XXXXXX” is a 6-digit passkey randomly generated during each pairing.
 - 1 Ensure that the passkeys appear on the unit and Bluetooth device are the same.
 - 2 Press the volume knob to confirm the passkey.
 - 3 Operate the Bluetooth device to confirm the passkey.
(B) “[Device Name]” → “VOL – YES” → “BACK – NO”
 - 1 Press the volume knob to start pairing.
 - 2 • If “PAIRING” → “PIN 0000” scrolls on the display, enter the PIN code “0000” into the Bluetooth device.
You can change to a desired PIN code before pairing. (→ 20)
• If only “PAIRING” appears, operate the Bluetooth device to confirm pairing.
- “PAIRING COMPLETED” appears when pairing is completed and “**Ⓞ**” will light up when the Bluetooth connection is established.
- This unit supports Secure Simple Pairing (SSP).
 - Up to five devices can be registered (paired) in total.
 - Once the pairing is completed, the Bluetooth device will remain registered in the unit even if you reset the unit. To delete the paired device, → 20, [DEVICE DELETE].
 - A maximum of two Bluetooth phones and one Bluetooth audio device can be connected at any time.
However, while in BT AUDIO source, you can connect to five Bluetooth audio devices and switch between these five devices. (→ 21)
 - Some Bluetooth devices may not automatically connect to the unit after pairing. Connect the device to the unit manually.
 - Refer to the instruction manual of the Bluetooth device for more information.

Auto Pairing

When you connect iPhone/iPod touch/Android device to the USB input terminal, pairing request (via Bluetooth) is automatically activated.

Press the volume knob to pair once you have confirmed the device name.

- Automatic pairing request is activated only if:
- Bluetooth function of the connected device is turned on.
 - [AUTO PAIRING] is set to [ON]. (➔ 20)
 - JVC MUSIC PLAY application is installed on the Android device (➔ 8) and [AUTO MODE] is selected (➔ 9).

BLUETOOTH — Mobile phone

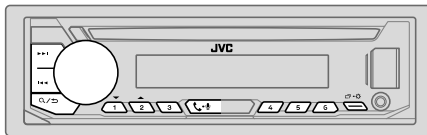

Receive a call

When there is an incoming call:

- **KD-R995BTS/KD-R990BTS/KD-R895BTS/KD-RD99BTS/KD-R99MBS:**
The buttons will blink in the color you have selected in [RING COLOR]. (➔ 18)
- **KD-R792BT/KD-R790BT/KD-RD79BT:**
The buttons will blink in the blinking pattern you have selected in [RING ILLUMI]. (➔ 18)
- The unit answers the call automatically if [AUTO ANSWER] is set to a selected time. (➔ 18)

During a call:

- **KD-R995BTS/KD-R990BTS/KD-R895BTS/KD-RD99BTS/KD-R99MBS:**
The buttons stop blinking and illuminate in the color you have selected in [RING COLOR]. (➔ 18)
- **KD-R792BT/KD-R790BT/KD-RD79BT:**
The buttons stop blinking.
- If you turn off the unit or detach the faceplate, the Bluetooth connection is disconnected.

The following operations may differ or not available depending on the connected phone.

To	On the faceplate	On the remote control
First incoming call...		
Answer a call	Press or the volume knob.	Press ///.
Reject a call	Press and hold or the volume knob.	Press and hold ///.
End a call	Press and hold or the volume knob.	Press and hold ///.

BLUETOOTH®

To	On the faceplate	On the remote control
While talking on the first incoming call...		
Answer another incoming call and hold the current call	Press - or the volume knob.	(Not available)
Reject another incoming call	Press and hold - or the volume knob.	(Not available)
While having two active calls...		
End current call and activate held call	Press and hold - or the volume knob.	Press and hold / / / .
Swap between the current call and held call	Press - .	(Not available)
Adjust the phone volume* ¹ [00] to [35] (Default: [15])	Turn the volume knob during a call.	Press VOL + * ² or VOL - during a call.
Switch between hands-free and private talk modes* ³	Press / during a call.	(Not available)

*¹ This adjustment will not affect the volume of the other sources.

*² Press and hold **VOL +** to continuously increase the volume to 15.

*³ Operations may vary according to the connected Bluetooth device.

Improve the voice quality

While talking on the phone...

- 1 Press and hold - .
- 2 Turn the volume knob to select an item (see the following table), then press the knob.
- 3 Repeat step 2 until the desired item is selected or activated.
- 4 Press - to exit.

To return to the previous setting item, press / .

Default: **XX**

MIC GAIN	LEVEL -10 to LEVEL +10 (LEVEL -04): The sensitivity of the microphone increases as the number increased.
NR LEVEL	LEVEL -05 to LEVEL +05 (LEVEL 00): Adjust the noise reduction level until the least noise is being heard during a phone conversation.
ECHO CANCEL	LEVEL -05 to LEVEL +05 (LEVEL 00): Adjust the echo cancellation delay time until the least echo is being heard during a phone conversation.

Make the settings for receiving a call

- 1 Press - to enter Bluetooth mode.
- 2 Turn the volume knob to select an item (see the following table), then press the knob.
- 3 Repeat step 2 until the desired item is selected or activated.

To return to the previous setting item, press / .

Default: **XX**

SETTINGS	
AUTO ANSWER	01 SEC to 30 SEC: The unit answers incoming call automatically in the selected time (in seconds). ; OFF : Cancels.
RING COLOR	KD-R995BTS/KD-R990BTS/KD-R895BTS/KD-RD998BTS/KD-R99MBS: COLOR 01 to COLOR 49 (COLOR 08): Selects the light color for the buttons as notification when there is an incoming call and during a call. ; OFF : Cancels.
RING ILLUMI	KD-R792BT/KD-R790BT/KD-RD79BT: BLINK 01 to BLINK 05 (BLINK 02): Selects the blinking pattern for the buttons as notification when there is an incoming call. ; OFF : Cancels.

BLUETOOTH®

BATT/SIGNAL* **KD-R995BTS/KD-R990BTS/KD-R895BTS/KD-RD99BTS/KD-R99MBS:**
AUTO: Shows the strength of the battery and signal when the unit detects a Bluetooth device and the Bluetooth device is connected. ; **OFF:** Cancels.

* Functionality depends on the type of the phone used.

Make a call

You can make a call from the call history, phonebook, or dialing the number. Call by voice is also possible if your mobile phone has the feature.

- 1 Press **📞** - **📞** to enter Bluetooth mode.
“(First device name)” appears.
 - If two Bluetooth phones are connected, press **📞** - **📞** again to switch to another phone.
“(Second device name)” appears.
- 2 Turn the volume knob to select an item (see the following table), then press the knob.
- 3 Repeat step 2 until the desired item is selected/activated or follow the instructions stated on the selected item.

To return to the previous setting item, press **🔍** / **🏠**.

RECENT CALL (Applicable only if the phone supports PBAP.)
1 Press the volume knob to select a name or a phone number.

- “<” indicates call received, “>” indicates call made, “M” indicates call missed.
- “NO HISTORY” appears if there is no recorded call history or call number.

2 Press the volume knob to call.

PHONEBOOK (Applicable only if the phone supports PBAP.)
1 Press **2 ▲** / **1 ▼** to select the desired letter (A to Z, 0 to 9, and OTHERS).

- “OTHERS” appears if the first character is other than A to Z, 0 to 9.

2 Turn the volume knob to select a name, then press the knob.
3 Turn the volume knob to select a phone number, then press the knob to call.

- The phonebook of the connected phone is automatically transferred to the unit when pairing.
- This unit can display only non-accent letters. (Accent letters such as “Ú” is shown as “U”).

DIAL NUMBER 1 Turn the volume knob to select a number (0 to 9) or character (*, #, +).
2 Press **⏪** / **⏩** to move the entry position.
Repeat steps 1 and 2 until you finish entering the phone number.
3 Press the volume knob to call.

VOICE Speak the name of the contact you want to call or the voice command to control the phone functions. (➡ **Make a call using voice recognition**)

Make a call using voice recognition

- 1 Press and hold **📞** - **📞** to activate the connected phone.
 - 2 Speak the name of the contact you want to call or the voice command to control the phone functions.
- Supported Voice Recognition features vary for each phone. Refer to the instruction manual of the connected phone for details.
 - This unit also supports the intelligent personal assistant function of iPhone.

Settings in memory

Store a contact in memory

You can store up to 6 contacts into the number buttons (1 to 6).

- 1 Press **📞** - **📞** to enter Bluetooth mode.
- 2 Turn the volume knob to select [RECENT CALL], [PHONEBOOK] or [DIAL NUMBER], then press the knob.
- 3 Turn the volume knob to select a contact or enter a phone number.
If a contact is selected, press the volume knob to show the phone number.
- 4 Press and hold one of the number buttons (1 to 6).
“MEMORY P(selected preset number)” appears when the contact is stored.

To erase a contact from the preset memory, select [DIAL NUMBER] in step 2 and store a blank number.

BLUETOOTH®

Make a call from memory

- 1 Press **⏏** **-** **📞** to enter Bluetooth mode.
- 2 Press one of the number buttons (1 to 6).
- 3 Press the volume knob to call.
"NO PRESET" appears if there is no contact stored.

Bluetooth mode settings

- 1 Press and hold **⏏** **-** **⚙**.
- 2 Turn the volume knob to select an item (see the following table), then press the knob.
- 3 Repeat step 2 until the desired item is selected/activated or follow the instructions stated on the selected item.
- 4 Press **⏏** **-** **⚙** to exit.

To return to the previous setting item, press **⏏** / **↩**.

Default: **XX**

BT MODE	
PHONE SELECT*	Selects the phone or audio device to connect or disconnect. "X" appears in front of the device name when connected.
AUDIO SELECT*	">" appears in front of the current playback audio device.
DEVICE DELETE	<ol style="list-style-type: none">1 Turn the volume knob to select a device to delete, then press the knob.2 Turn the volume knob to select [YES] or [NO], then press the knob.
PIN CODE EDIT (0000)	Changes the PIN code (up to 6 digits). <ol style="list-style-type: none">1 Turn the volume knob to select a number.2 Press ⏏ ← / → ⏏ to move the entry position. Repeat steps 1 and 2 until you finish entering the PIN code.3 Press the volume knob to confirm.
RECONNECT	ON : The unit automatically reconnect when the last connected Bluetooth device is within range. ; OFF : Cancels.
AUTO PAIRING	ON : The unit automatically pair supported Bluetooth device (iPhone/iPod touch/Android device) when it is connected through USB input terminal. Depending on the operating system of the connected device, this function may not work. ; OFF : Cancels.

INITIALIZE	YES : Initializes all the Bluetooth settings (including stored pairing, phonebook, and etc.). ; NO : Cancels.
INFORMATION	MY BT NAME : Displays the unit name ("KD-R9x×BTS"/"KD-R8x×BTS"/"KD-R7x×BT"/ "KD-RD9x×BTS"/"KD-RD7x×BT"/"KD-R9x×MBS"). ; MY ADDRESS : Shows address of this unit.

* You can only connect a maximum of two Bluetooth phones and one Bluetooth audio device at any time.

Bluetooth compatibility check mode

You can check the connectivity of the supported profile between the Bluetooth device and the unit.

• Make sure there is no Bluetooth device paired.

- 1 Press and hold **⏏** **-** **📞**.
"BLUETOOTH" ↔ "CHECK MODE" appears. "SEARCH NOW USING PHONE" → "PIN IS 0000" scrolls on the display.
- 2 Search and select "KD-R9x×BTS"/"KD-R8x×BTS"/
"KD-R7x×BT"/"KD-RD9x×BTS"/"KD-RD7x×BT"/
"KD-R9x×MBS" on the Bluetooth device within 3 minutes.
- 3 Perform (A), (B) or (C) depending on what appears on the display.
(A) "PAIRING" → "XXXXXX" (6-digit passkey): Ensure that the same passkey appears on the unit and Bluetooth device, then operate the Bluetooth device to confirm the passkey.
(B) "PAIRING" → "PIN IS 0000": Enter "0000" on the Bluetooth device.
(C) "PAIRING": Operate the Bluetooth device to confirm pairing.

BLUETOOTH®

After pairing is successful, "PAIRING OK"

→ "[Device Name]" appears and Bluetooth compatibility check starts.

If "CONNECT NOW USING PHONE" appears, operate the Bluetooth device to allow phonebook access to continue.

"TESTING" flashes on the display.

The connectivity result flashes on the display.

"PAIRING OK" and/or "HANDS-FREE OK"*1 and/or "AUD.STREAM OK"*2 and/or "PBAP OK"*3 : Compatible

*1 Compatible with Hands-Free Profile (HFP)

*2 Compatible with Advanced Audio Distribution Profile (A2DP)

*3 Compatible with Phonebook Access profile (PBAP)

After 30 seconds, "PAIRING DELETED" appears to indicate that pairing has been deleted, and the unit exits check mode.

- To cancel, press and hold **SRC** to turn off the power, then turn on the power again.

BLUETOOTH — Audio

While in BT AUDIO source, you can connect to five Bluetooth audio devices and switch between these five devices.

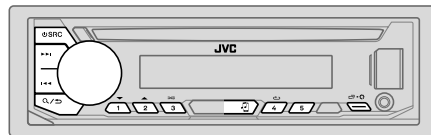

Audio player via Bluetooth

- 1 Press **SRC** repeatedly to select BT AUDIO (or press **SOURCE** on the remote control).
 - Pressing **BT** enters BT AUDIO directly.
- 2 Operate the Bluetooth audio player to start playback.

To	On the faceplate	On the remote control
Playback/pause	Press the volume knob.	Press ⏸ .
Select group or folder	Press 2 ▲ / 1 ▼ .	Press ▲ / ▼ .
Reverse skip/Forward skip	Press ⏮ / ⏭ .	Press ◀ / ▶ .
Reverse/Fast-forward	Press and hold ⏮ / ⏭ .	Press and hold ◀ / ▶ .
Repeat play	Press 4 ↺ repeatedly. TRACK REPEAT, ALL REPEAT, REPEAT OFF	(Not available)
Random play	Press 3 ↻ repeatedly. GROUP RANDOM, ALL RANDOM, RANDOM OFF	(Not available)
Select a file from a folder/ list	Refer to "Select a file from a folder/list" on page 9.	(Not available)
Switch between connected Bluetooth audio devices	Press 5 *	(Not available)

* Pressing the "Play" key on the connected device itself also causes switching of sound output from the device.



Operations and display indications may differ according to their availability on the connected device.



Settings to use JVC Remote application

JVC Remote application is designed to control the JVC car receiver's operations from the iPhone/iPod (via Bluetooth or via USB input terminal) or Android smartphone (via Bluetooth).

Preparation:

Install the latest version of JVC Remote application on your device before connecting.

- 1 Press and hold .
- 2 Turn the volume knob to select an item (see the following table), then press the knob.
- 3 Repeat step 2 until the desired item is selected or activated.
- 4 Press  to exit.

To return to the previous setting item, press  / .

Default: **XX**

REMOTE APP	
SELECT	Select the device (IOS or ANDROID) to use the application.
IOS	<p>YES: Selects iPhone/iPod to use the application via Bluetooth or connected via USB input terminal. ; NO: Cancels.</p> <p>If IOS is selected, select iPod BT source (or iPod USB if your iPhone/iPod is connected via USB input terminal) to activate the application.</p> <ul style="list-style-type: none"> • The connectivity of the application will be interrupted or disconnected if: <ul style="list-style-type: none"> – You change from iPod BT source to any playback source connected via the USB input terminal. – You change from iPod USB source to iPod BT source.
ANDROID	YES: Selects Android smartphone to use the application via Bluetooth. ; NO: Cancels.
ANDROID LIST*	Selects the Android smartphone to use from the list.

* Displayed only when [ANDROID] of [SELECT] is set to [YES].

STATUS

Shows the status of the selected device.

IOS CONNECTED: You are able to use the application using the iPhone/iPod connected via Bluetooth or USB input terminal.

IOS NOT CONNECTED: No IOS device is connected to use the application.

ANDROID CONNECTED: You are able to use the application using the Android smartphone connected via Bluetooth.

ANDROID NOT CONNECTED: No Android device is connected to use the application.

Listen to iPhone/iPod via Bluetooth

You can listen to the songs on the iPhone/iPod via Bluetooth on this unit.

Press  **SRC** repeatedly to select iPod BT.

- You can operate the iPod/iPhone in the same way as iPod/iPhone via USB input terminal. (➡ 8)
- If you plug in an iPhone/iPod to the USB input terminal while listening to iPod BT source, the source automatically change to iPod USB. Press  **SRC** to select iPod BT if the device is still connected via Bluetooth.

Internet radio via Bluetooth

You can listen to internet radio (Pandora, iHeartRadio and Spotify) on the iPhone/iPod touch/Android device via Bluetooth on this unit.

- Make sure the USB input terminal is not connected to any device.

Listen to Pandora (except KD-R792BT)

Preparation:

Select [ON] for [PANDORA SRC] in [SOURCE SELECT]. (→ 4)

- 1 Open the Pandora application on your device.
- 2 Connect your device via Bluetooth connection. (→ 16)
- 3 Press **ⓄSRC** repeatedly to select PANDORA (for iPhone/iPod) or PANDORA BT (for Android device).

The source switches and broadcast starts automatically.

- You can operate Pandora in the same way as Pandora via USB input terminal. (→ 10)

Listen to iHeartRadio (except KD-R792BT)

Preparation:

Select [ON] for [IHEART SRC] in [SOURCE SELECT]. (→ 4)

- 1 Open the iHeartAuto application on your device.
- 2 Connect your device via Bluetooth connection. (→ 16)
- 3 Press **ⓄSRC** repeatedly to select IHEART RADIO.

The source switches and broadcast starts automatically.

- You can operate iHeartRadio in the same way as iHeartRadio via USB input terminal. (→ 11)

Listen to Spotify

Preparation:

Select [ON] for [SPOTIFY SRC] in [SOURCE SELECT]. (→ 4)

- 1 Open the Spotify application on your device.
- 2 Connect your device via Bluetooth connection. (→ 16)
- 3 Press **ⓄSRC** repeatedly to select SPOTIFY (for iPhone/iPod) or SPOTIFY BT (for Android device).

The source switches and broadcast starts automatically.

- You can operate Spotify in the same way as Spotify via USB input terminal. (→ 12)

AUX

Use a portable audio player

1 Connect a portable audio player (commercially available).

3.5 mm (1/8") stereo mini plug with "L" shaped connector (commercially available)

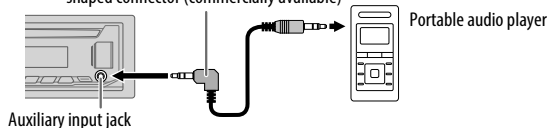

2 Select [ON] for [BUILT-IN AUX] in [SOURCE SELECT]. (→ 4)

3 Press **SRC** repeatedly to select AUX.

4 Turn on the portable audio player and start playback.



Use a 3-core plug head stereo mini plug for optimum audio output.

AUDIO SETTINGS

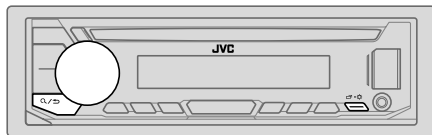

1 Press and hold **↩** + **⊙**.

2 Turn the volume knob to select an item (see the following table), then press the knob.

3 Repeat step 2 until the desired item is selected/activated or follow the instructions stated on the selected item.

4 Press **↩** + **⊙** to exit.

To return to the previous setting item, press **Q** / **▷**.

Default: **XX**

EQ SETTING

PRESET EQ

Select a preset equalizer suitable to the music genre.

- Select [USER] to use the settings made in [EASY EQ] or [PRO EQ].

FLAT/DRVN 3/DRVN 2/DRVN 1/HARD ROCK/HIP HOP/JAZZ/POP/R&B/USER/CLASSICAL

Drive equalizer (**DRVN 3/DRVN 2/DRVN 1**) boosts specific frequencies in the audio signal to reduce the noise heard from outside the car or running noise of the tyres.

EASY EQ

Adjust your own sound settings.

- The settings are stored to [USER].
- The settings made may affect the current settings of [PRO EQ].

SUB.W SP*1*2: **00 to +06** (Default: **+03**)

SUB.W*1*3: **-50 to +10** **00**

BASS: **LVL-09 to LVL+09** **LVL 00**

MID: **LVL-09 to LVL+09** **LVL 00**

TRE: **LVL-09 to LVL+09** **LVL 00**

*1, *2, *3: (→ 25)

AUDIO SETTINGS

PRO EQ	Adjust your own sound settings. • The settings are stored to [USER]. • The settings made may affect the current settings of [EASY EQ].
62.5HZ	LEVEL -09 to LEVEL +09 (LEVEL 00): Adjusts the level to memorize for each source. (Before making an adjustment, select the source you want to adjust.) ON: Turns on the extended bass. ; OFF: Cancels.
100HZ/160HZ/250HZ/400HZ/630HZ/1KHZ/1.6KHZ/2.5KHZ/4KHZ/6.3KHZ/10KHZ/16kHz	LEVEL -09 to LEVEL +09 (LEVEL 00): Adjusts the level to memorize for each source. (Before making an adjustment, select the source you want to adjust.)
Q FACTOR	1.35/1.50/2.00: Adjust the quality factor.
AUDIO CONTROL	
BASS BOOST	LEVEL +01 to LEVEL +05: Selects your preferred bass boost level. ; OFF: Cancels.
LOUDNESS	LEVEL 01/LEVEL 02: Boosts low or high frequencies to produce a well-balanced sound at low volume. ; OFF: Cancels.
SUB.W LEVEL *1	SPK-OUT *2 (Not applicable when 3-way crossover is selected.) SUB.W 00 to SUB.W +06 (SUB.W +03): Adjusts the output level of the subwoofer connected via speaker lead. (➔ 42)
	PRE-OUT *3 SUB.W -50 to SUB.W +10 (SUB.W 00): Adjusts the output level of the subwoofer connected to the lineout terminals (SW or REAR/SW) through an external amplifier. (➔ 43)
SUBWOOFER SET *3	ON: Turns on the subwoofer output. ; OFF: Cancels.
FADER	(Not applicable when 3-way crossover is selected.) POSITION R15 to POSITION F15 (POSITION 00): Adjusts the front and rear speaker output balance.
BALANCE *4	POSITION L15 to POSITION R15 (POSITION 00): Adjusts the left and right speaker output balance.
VOLUME ADJUST	LEVEL -15 to LEVEL +06 (LEVEL 00): Preset the initial volume level of each source (compared to the FM volume level). Before adjustment, select the source you want to adjust.
AMP GAIN	LOW POWER: Limits the maximum volume level to 25. (Select if the maximum power of each speaker is less than 50 W to prevent damaging the speakers.) ; HIGH POWER: The maximum volume level is 35.
SPK/PRE OUT	(Not applicable when 3-way crossover is selected.) Depending on the speaker connection method, select the appropriate setting to get the desired output. (➔ 26, Speaker output settings)
SPEAKER SIZE	Depending on the crossover type you have selected (➔ [X ' OVER TYPE]), 2-way crossover or 3-way crossover setting items will be shown. (➔ 27, Crossover settings)
X ' OVER	By default, 2-way crossover type is selected.
DTA SETTINGS	For settings, ➔ 28, Digital Time Alignment settings .
CAR SETTINGS	
X ' OVER TYPE	Caution: Adjust the volume before changing the [X ' OVER TYPE] to avoid the sudden increase or decrease of the output level.
2-WAY	(Displayed only when [3-WAY] is selected.) YES: Selects two way crossover type. ; NO: Cancels.
3-WAY	(Displayed only when [2-WAY] is selected.) YES: Selects three way crossover type. ; NO: Cancels.

*1 Displayed only when [SUBWOOFER SET] is set to [ON].

*2 For 2-way crossover: Displayed only when [SPK/PRE OUT] is set to [SUB.W/SUB.W]. (➔ 26)

*3 For 2-way crossover: Displayed only when [SPK/PRE OUT] is set to [REAR/SUB.W] or [SUB.W/SUB.W]. (➔ 26)

*4 This adjustment will not affect the subwoofer output.

AUDIO SETTINGS

SOUND EFFECT	
SPACE ENHANCE	(Not applicable for TUNER source.) SMALL/MEDIUM/LARGE: Virtually enhances the sound space. ; OFF: Cancels.
SND RESPONSE	LEVEL1/LEVEL2/LEVEL3: Virtually makes the sound more realistic. ; OFF: Cancels.
SOUND LIFT	LOW/MIDDLE/HIGH: Virtually adjust the sound position heard from the speakers. ; OFF: Cancels.
VOL LINK EQ	ON: Boosts the frequency to reduce the noise heard from outside the car or running noise of the tyres. ; OFF: Cancels.
K2 TECHNOLOGY	(Not applicable for TUNER source, SIRIUS XM source and AUX source.) ON: Improve the sound quality of compressed music. ; OFF: Cancels.

Speaker output settings [SPK/PRE OUT]

(Applicable only if [X ' OVER TYPE] is set to [2-WAY]) (→ 25)

Select the output setting for the speakers [SPK/PRE OUT], based on the speaker connection method.

■ Connection via lineout terminals

For connections through an external amplifier. (→ 43)

KD-R995BTS/KD-R895BTS/KD-R99MB5:

Setting on [SPK/PRE OUT]	Audio signal through lineout terminal		
	FRONT	REAR	SW
REAR/REAR (default)	Front speakers output	Rear speakers output	Subwoofer output
REAR/SUB.W	(Not available)	(Not available)	(Not available)
SUB.W/SUB.W	Front speakers output	L (left): Subwoofer output R (right): (Mute)	Subwoofer output

KD-R990BTS/KD-R792BTKD-RD99BTS:

Setting on [SPK/PRE OUT]	Audio signal through lineout terminal	
	FRONT	REAR/SW
REAR/REAR	Front speakers output	Rear speakers output
REAR/SUB.W (default)	Front speakers output	Subwoofer output
SUB.W/SUB.W	Front speakers output	Subwoofer output

KD-R790BT/KD-RD79BT:

Setting on [SPK/PRE OUT]	Audio signal through lineout terminal	
	REAR/SW	
REAR/REAR	Rear speakers output	
REAR/SUB.W (default)	Subwoofer output	
SUB.W/SUB.W	Subwoofer output	

■ Connection via speaker leads

For connections without using an external amplifier. However, with this settings you can also enjoy the subwoofer output. (→ 42)

Setting on [SPK/PRE OUT]	Audio signal through rear speaker lead	
	L (left)	R (right)
REAR/REAR	Rear speakers output	Rear speakers output
REAR/SUB.W	Rear speakers output	Rear speakers output
SUB.W/SUB.W	Subwoofer output	(Mute)

If [SUB.W/SUB.W] is selected:

- [120HZ] is selected in [SUBWOOFER LPF] and [THROUGH] is not available.
- [POSITION R02] is selected in [FADER] and selectable range is [POSITION R15] to [POSITION 00].

AUDIO SETTINGS

Crossover settings

Below are the available setting items for 2-way crossover and 3-way crossover.

▲ Caution

Select a crossover type according to how the speakers are connected.
(→ 42, 43)

If you select a wrong type:

- The speakers may damage.
- The output sound level may be extremely high or low.

SPEAKER SIZE

Selects according to the connected speaker size for optimum performance.

- The frequency and slope settings are automatically set for the crossover of the selected speaker.
- When 2-way crossover is selected, if [NONE] is selected for [TWEETER] of [FRONT], [REAR] and [SUBWOOFER] for [SPEAKER SIZE], the [X' OVER] setting of the selected speaker is not available.
- When 3-way crossover is selected, if [NONE] is selected for [WOOFER] of [SPEAKER SIZE], the [X' OVER] setting of [WOOFER] is not available.

X' OVER (crossover)

- [FRQ]/[F-HPF FRQ]/[R-HPF FRQ]/[SW LPF FRQ]/[HPF FRQ]/[LPF FRQ]: Adjusts the crossover frequency for the selected speakers (high pass filter or low pass filter).
If [THROUGH] is selected, all signals are sent to the selected speakers.
- [SLOPE]/[F-HPF SLOPE]/[R-HPF SLOPE]/[SW LPF SLOPE]/[HPF SLOPE]/[LPF SLOPE]: Adjusts the crossover slope.
Selectable only if a setting other than [THROUGH] is selected for the crossover frequency.
- [SW LPF PHASE]/[PHASE]: Selects the phase of the speaker output to be in line with the other speaker output.
- [GAIN LEFT]/[GAIN RIGHT]/[F-HPF GAIN]/[R-HPF GAIN]/[SW LPF GAIN]/[GAIN]: Adjusts the output volume of the selected speaker.

2-way crossover setting items

SPEAKER SIZE

FRONT	SIZE	3.5"/4"/4.75"/5"/6.5"/6.75"/7"/4×6/5×7/6×8/ 6×9/7×10
	TWEETER	SMALL/MIDDLE/LARGE/NONE (not connected)
REAR*1	SIZE	3.5"/4"/4.75"/5"/6.5"/6.75"/7"/4×6/5×7/6×8/6×9/7×10/ NONE (not connected)
SUBWOOFER*2*3	SIZE	6.5"/8"/10"/12"/15" OVER/NONE (not connected)

X' OVER

TWEETER	FRQ	1KHZ/1.6KHZ/2.5KHZ/4KHZ/5KHZ/6.3KHZ/8KHZ/ 10KHZ/12.5KHZ
	GAIN LEFT	-08DB to 00DB
	GAIN RIGHT	-08DB to 00DB
FRONT HPF	F-HPF FRQ	30HZ/40HZ/50HZ/60HZ/70HZ/80HZ/90HZ/100HZ/ 120HZ/150HZ/180HZ/220HZ/250HZ/THROUGH
	F-HPF SLOPE	-06DB/-12DB/-18DB/-24DB
	F-HPF GAIN	-08DB to 00DB
REAR HPF*1	R-HPF FRQ	30HZ/40HZ/50HZ/60HZ/70HZ/80HZ/90HZ/100HZ/ 120HZ/150HZ/180HZ/220HZ/250HZ/THROUGH
	R-HPF SLOPE	-06DB/-12DB/-18DB/-24DB
	R-HPF GAIN	-08DB to 00DB
SUBWOOFER LPF*2*3	SW LPF FRQ	30HZ/40HZ/50HZ/60HZ/70HZ/80HZ/90HZ/100HZ/ 120HZ/150HZ/180HZ/220HZ/250HZ/THROUGH
	SW LPF SLOPE	-06DB/-12DB/-18DB/-24DB
	SW LPF PHASE	REVERSE (180°)/NORMAL (0°)
	SW LPF GAIN	-08DB to 00DB

*1, *2, *3: (→ 28)

AUDIO SETTINGS

3-way crossover setting items

SPEAKER SIZE

TWEETER	SMALL/MIDDLE/LARGE
MID RANGE	3.5"/4"/4.75"/5"/6.5"/6.75"/7"/4×6/5×7/6×8/6×9
WOOFER*3	6.5"/8"/10"/12"/15" OVER/NONE (not connected)

X ' OVER

TWEETER	HPF FRQ	1KHZ/1.6KHZ/2.5KHZ/4KHZ/5KHZ/6.3KHZ/8KHZ/10KHZ/12.5KHZ
	SLOPE	-06DB/-12DB
	PHASE	REVERSE (180°)/NORMAL (0°)
	GAIN	-08DB to 00DB
MID RANGE	HPF FRQ	30HZ/40HZ/50HZ/60HZ/70HZ/80HZ/90HZ/100HZ/120HZ/ 150HZ/180HZ/220HZ/250HZ/THROUGH
	HPF SLOPE	-06DB/-12DB
	LPF FRQ	1KHZ/1.6KHZ/2.5KHZ/4KHZ/5KHZ/6.3KHZ/8KHZ/ 10KHZ/12.5KHZ/THROUGH
	LPF SLOPE	-06DB/-12DB
	PHASE	REVERSE (180°)/NORMAL (0°)
	GAIN	-08DB to 00DB
WOOFER*3	LPF FRQ	30HZ/40HZ/50HZ/60HZ/70HZ/80HZ/90HZ/100HZ/120HZ/ 150HZ/180HZ/220HZ/250HZ/THROUGH
	SLOPE	-06DB/-12DB
	PHASE	REVERSE (180°)/NORMAL (0°)
	GAIN	-08DB to 00DB

*1 Displayed only when [SPK/PRE OUT] is set to [REAR/REAR] or [REAR/SUB.W]. (→ 26)

*2 Except KD-R995BTS/KD-R895BTS/KD-R99MBS: Displayed only when [SPK/PRE OUT] is set to [REAR/SUB.W] or [SUB.W/SUB.W]. (→ 26)

*3 Displayed only when [SUBWOOFER SET] is set to [ON]. (→ 25)

Digital Time Alignment settings

Digital Time Alignment sets the delay time of the speaker output to create a more suitable environment for your vehicle.

- For more information, → 29, Determining the value for [DISTANCE] and [GAIN] of [DTA SETTINGS].

DTA SETTINGS

POSITION	Selects your listening position (reference point). ALL: Not compensating ; FRONT RIGHT: Front right seat ; FRONT LEFT: Front left seat ; FRONT ALL: Front seat • [FRONT ALL] is displayed only when [X ' OVER TYPE] is set to [2-WAY]. (→ 25)
DISTANCE*1	0FT to 20.01FT: Fine adjust the distance to compensate.
GAIN*1	-8DB to 0DB: Fine adjust the output volume of the selected speaker.
DTA RESET	YES: Resets the settings ([DISTANCE] and [GAIN]) of the selected [POSITION] to default. ; NO: Cancels.

CAR SETTINGS

CAR TYPE	COMPACT/FULL SIZE CAR/WAGON/MINIVAN/SUV/ MINIVAN(LONG): Selects the type of vehicle. ; OFF: Not compensating.
R-SP LOCATION*2	Selects the location of the rear speakers in your vehicle to calculate the furthest distance from the listening position selected (reference point). • DOOR/REAR DECK: Selectable only when [CAR TYPE] is selected as [OFF], [COMPACT], [FULL SIZE CAR], [WAGON] or [SUV]. • 2ND ROW/3RD ROW: Selectable only when [CAR TYPE] is selected as [MINIVAN] or [MINIVAN(LONG)].

*1, *2: (→ 29)

AUDIO SETTINGS

Determining the value for [DISTANCE] and [GAIN] of [DTA SETTINGS]

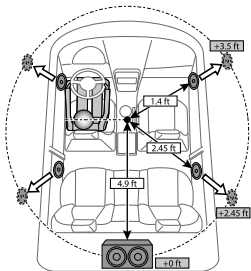

If you specify the distance from the center of the currently set listening position to every speaker, the delay time will be automatically computed and set.

- 1 Determine the center of the currently set listening position as the reference point.
- 2 Measure the distances from the reference point to the speakers.
- 3 Calculate the differences between the distance of the furthest speaker (rear speaker) and other speakers.
- 4 Set the [DISTANCE] calculated in step 3 for individual speakers.
- 5 Adjust [GAIN] for individual speakers.

Example: When [FRONT ALL] is selected as the listening position

*1 Before making an adjustment, select the speaker:

When 2-way crossover is selected:

FRONT LEFT/FRONT RIGHT/REAR LEFT/REAR RIGHT/SUBWOOFER:

- [REAR LEFT], [REAR RIGHT] and [SUBWOOFER] is selectable only if a setting other than [NONE] is selected for [REAR] and [SUBWOOFER] of [SPEAKER SIZE]. (→ 27)

When 3-way crossover is selected:

TWEETER LEFT/TWEETER RIGHT/MID LEFT/MID RIGHT/WOOFER:

- [WOOFER] is selectable only if a setting other than [NONE] is selected for [WOOFER] of [SPEAKER SIZE]. (→ 28)

*2 Displayed only when [X' OVER TYPE] is set to [2-WAY] (→ 25) and if a setting other than [NONE] is selected for [REAR] of [SPEAKER SIZE]. (→ 27)

DISPLAY SETTINGS

Zone identification for brightness setting

KD-R995BTS/KD-R990BTS/KD-R895BTS/
KD-RD99BTS



KD-R792BT/KD-R790BT/KD-RD79BT/
KD-R99MBS

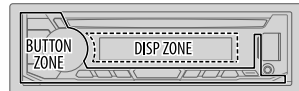

Zone identification for color setting

KD-R995BTS/KD-R990BTS/KD-R895BTS/
KD-RD99BTS

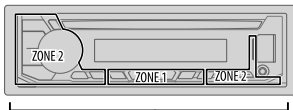

KD-R99MBS

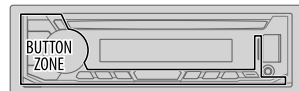

ALL ZONE

- 1 Press and hold to enter settings.
- 2 Turn the volume knob to select an item (→ 30), then press the knob.
- 3 Repeat step 2 until the desired item is selected/activated or follow the instructions stated on the selected item.
- 4 Press to exit.

To return to the previous setting item, press / .

DISPLAY SETTINGS

Default: **XX**

DISPLAY	
DIMMER	Dim the illumination. OFF: Dimmer is turned off. Brightness changes to [DAY] setting. ON: Dimmer is turned on. Brightness changes to [NIGHT] setting. (→ [BRIGHTNESS]) DIMMER TIME: Set the dimmer on and off time. 1 Turn the volume knob to adjust the [ON] time, then press the knob. 2 Turn the volume knob to adjust the [OFF] time, then press the knob. (Default: [ON]: PM6:00 ; [OFF]: AM6:00) DIMMER AUTO: Dimmer turns on and off automatically when you turn off or on the car headlights.*1
BRIGHTNESS	Set the brightness for day and night separately. 1 DAY/NIGHT: Select day or night. 2 Select a zone. (→ 29) 3 LEVEL 00 to LEVEL 31: Set the brightness level.
TEXT SCROLL *2	SCROLL ONCE: Scrolls the display information once.; SCROLL AUTO: Repeats scrolling at 5-second intervals.; SCROLL OFF: Cancels.
COLOR (for KD-R995BTS/KD-R990BTS/KD-R895BTS/KD-RD99BTS)	
PRESET	Select illumination colors for the buttons on different zones separately. 1 Select a zone. (→ 29) 2 Select a color for the selected zone. <ul style="list-style-type: none">• COLOR 01 to COLOR 49• USER: The color you have created for [DAY COLOR] or [NIGHT COLOR] is shown.• COLOR FLOW01 to COLOR FLOW03: Color changes at different speeds.• CRYSTAL/FLOWER/FOREST/GRADATION/OCEAN/SUNSET/RELAX: The selected color pattern is shown.*3 (Selectable only when [ALL ZONE] is selected in step 1.)

DAY COLOR	Store your own day and night illumination colors for different zones. 1 Select a zone. (→ 29) 2 RED/GREEN/BLUE: Select a primary color. 3 00 to 31: Select the level.
NIGHT COLOR	Repeat steps 2 and 3 for all the primary colors. <ul style="list-style-type: none">• Your setting is stored to [USER] in [PRESET].• [NIGHT COLOR] or [DAY COLOR] is changed by turning on or off your car's headlight.
COLOR GUIDE	ON: Changes the button illumination when settings are performed on menu and list search.; OFF: Cancels.
COLOR (for KD-R99MBS)	
PRESET	Select illumination colors for the buttons. <ul style="list-style-type: none">• COLOR 01 to COLOR 49• USER: The color you have created for [DAY COLOR] or [NIGHT COLOR] is shown.• COLOR FLOW01 to COLOR FLOW03: Color changes at different speeds.
DAY COLOR	Store your own day and night illumination colors for the buttons. 1 RED/GREEN/BLUE: Select a primary color. 2 00 to 31: Select the level.
NIGHT COLOR	Repeat steps 1 and 2 for all the primary colors. <ul style="list-style-type: none">• Your setting is stored to [USER] in [PRESET].• [NIGHT COLOR] or [DAY COLOR] is changed by turning on or off your car's headlight.

*1, *2, *3: (→ 31)

DISPLAY SETTINGS

MENU COLOR **ON:** The color of button illumination changes to white color when in menu mode or when selecting a music file from a folder/list.; **OFF:** Cancels.

- *1 The illumination control wire connection is required. (→ 42)
- *2 Some characters or symbols will not be shown correctly (or will be blanked).
- *3 If one of these color pattern is selected, the [ZONE 1] and [ZONE 2] illumination colors will change to the default colors.

LEARNING STEERING REMOTE CONTROL (for KD-R792BT)

You can control the unit with the steering remote control keys on your vehicle. After connection, you can configure the control keys according to your preference.

- You can only make this configuration if your vehicle is equipped with the electrical steering remote control.
- If the steering remote control in your car is not compatible, configuration may not be completed and an error message may appear. (→ 36)

Make the connection

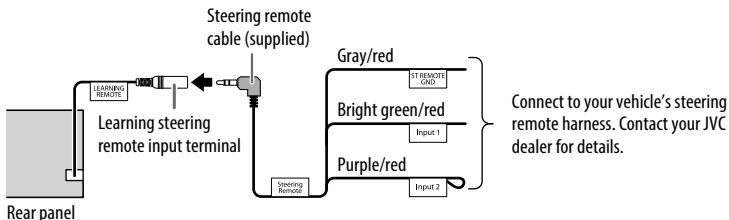

Configure the control keys

- 1 Press and hold .
- 2 Turn the volume knob to select [SYSTEM], then press the knob.
- 3 Turn the volume knob to select [USER S.REMO], then press the knob.
- 4 Turn the volume knob to select [SET KEY], then press the knob.
A key list of 16 assignable keys appears.
 - K## NONE: No function has been assigned.
- 5 Turn the volume knob to select any key from the key list to assign the function, then press the knob.
"PRESS KEY TO ASSIGN K##" appears.

LEARNING STEERING REMOTE CONTROL (for KD-R792BT)

- 6 Press and hold any control keys on your steering remote control which you want to assign.**

A list of key functions will appear on the display.

NONE (default)/MUTE/SEEK UP/SEEK DOWN/VOL UP/VOL DOWN/MODE/ON HOOK/OFF HOOK/VOICE/ENTER

- 7 Turn the volume knob to select a function to assign, then press the knob.**
The selected key function is assigned to the steering remote control key you have selected in step 6.

The display returns to the key list as on step 4.

- **K## (Function):** When certain function has been assigned to a key.

- 8 Repeat steps 5, 6 and 7 to assign other control keys.**
9 Press \square \cdot \star to exit.

To reassign the control keys

- 1 Press and hold \square \cdot \star .**
- 2 Turn the volume knob to select [SYSTEM], then press the knob.**
- 3 Turn the volume knob to select [USER S.REMO], then press the knob.**
- 4 Turn the volume knob to select [RESET KEY], then press the knob.**
- 5 Turn the volume knob to select [YES], then press the knob.**

All the control keys will be reset.

Selecting [NO] will cancel the operation.

When [FACTORY RESET] is set to [YES] (\rightarrow 5), it will also reset the learning remote control.

To return to the previous setting item, press \mathcal{Q} / \rightarrow .

REFERENCES

■ Maintenance

Cleaning the unit

Wipe off dirt on the faceplate with a dry silicone or soft cloth.

Cleaning the connector

Detach the faceplate and clean the connector gently with a cotton swab, being careful not to damage the connector.



Connector (on the reverse side of the faceplate)

Handling discs:

- Do not touch the recording surface of the disc.
- Do not stick tape etc. on the disc, or use a disc with tape stuck on it.
- Do not use any accessories for the disc.
- Clean from the center of the disc and move outward.
- Clean the disc with a dry silicone or soft cloth. Do not use any solvents.
- When removing discs from this unit, pull them out horizontally.
- Remove burrs from the center hole and disc edge before inserting a disc.

General

- This unit can only play the following CDs:



- **DualDisc playback:** The Non-DVD side of a "DualDisc" does not comply with the "Compact Disc Digital Audio" standard. Therefore, the use of Non-DVD side of a DualDisc on this product cannot be recommended.

REFERENCES

Playable files

- Playable audio file:

For disc: MP3 (.mp3), WMA (.wma), AAC (.aac)

For USB mass storage class device:

MP3 (.mp3), WMA (.wma), AAC (.aac), AAC (.m4a), WAV (.wav), FLAC (.flac)

- Playable disc media: CD-R/CD-RW/CD-ROM
- Playable disc file format: ISO 9660 Level 1/2, Joliet, Long file name.
- Playable USB device file system: FAT12, FAT16, FAT32

Even when audio files comply with the standards listed above, playback may be impossible depending on the types or conditions of media or device.

The AAC (.m4a) file in a CD encoded by iTunes cannot be played on this unit.

Unplayable discs

- Discs that are not round.
- Discs with coloring on the recording surface or discs that are dirty.
- Recordable/ReWritable discs that have not been finalized.
- 8 cm CD. Attempting to insert using an adapter may cause malfunction.

About USB devices

- You cannot connect a USB device via a USB hub.
- Connecting a cable whose total length is longer than 5 m may result in abnormal playback.
- This unit cannot recognize a USB device whose rating is other than 5 V and exceeds 1.5 A.

About iPod/iPhone

- Via USB input terminal:

Made for

- iPod touch (5th and 6th generation)
- iPod nano (7th generation)
- iPhone 4S, 5, 5S, 5C, 6, 6 Plus, 6S, 6S Plus, SE, 7, 7 Plus

- Via Bluetooth:

Made for

- iPod touch (5th and 6th generation)
- iPhone 4S, 5, 5S, 5C, 6, 6 Plus, 6S, 6S Plus, SE, 7, 7 Plus

- It is not possible to browse video files on the “Videos” menu in [HEAD MODE].
- The song order displayed on the selection menu of this unit may differ from that of the iPod/iPhone.

- Depending on the version of the operating system of the iPod/iPhone, some functions may not operate on this unit.

About Android device

- This unit supports Android OS 4.1 and above.
- Some Android devices (with OS 4.1 and above) may not fully support Android Open Accessory (AOA) 2.0.
- If the Android device supports both mass storage class device and AOA 2.0, this unit always playback via AOA 2.0 as priority.

About iHeartRadio

- iHeartRadio® is a third-party service, therefore the specifications are subject to change without prior notice. Accordingly, compatibility may be impaired or some or all of the services may become unavailable.
- Some iHeartRadio® functionality cannot be operated from this unit.

About Spotify

- Spotify application supports:
 - iPhone 4S, 5, 5S, 5C, 6, 6 Plus, 6S, 6S Plus, SE, 7, 7 Plus (iOS 8 or above)
 - iPod touch (5th and 6th generation)
 - Android OS 4.0.3 or above
- Spotify is a third party service, therefore the specifications are subject to change without prior notice. Accordingly, compatibility may be impaired or some or all of the services may become unavailable.
- Some functions of Spotify cannot be operated from this unit.

REFERENCES

About Bluetooth

- Depending on the Bluetooth version of the device, some Bluetooth devices may not be able to connect to this unit.
- This unit may not work with some Bluetooth devices.
- Signal conditions vary, depending on the surroundings.

Change the display information

Each time you press   , the display information changes.

- If the information is unavailable or not recorded, "NO TEXT", "NO NAME", or other information (eg. station name) appears or display will be blank.

Source name	Display information	
	KD-R995BTS/KD-R990BTS/KD-R895BTS/KD-RD99BTS/KD-R99MBS	KD-R792BT/KD-R790BT/KD-RD79BT
FM or AM	Frequency (Date/Clock)*1 → Frequency (Date) with music synchronisation*2 → (back to the beginning)	Frequency → Clock → Frequency with music synchronisation*2 → (back to the beginning)
	(For FM Radio Broadcast Data System stations only) Station name (PS)/Program type (PTY) (Date/Clock)*1 → Radio text (Date/Clock)*1 → Radio text+ (Radio text+) → Song title (Artist) → Song title (Date/Clock)*1 → Frequency (Date/Clock)*1 → Station name (PS)/Program type (PTY) (Date) with music synchronisation*2 → (back to the beginning)	(For FM Radio Broadcast Data System stations/FM Radio Data signal only) Station name (PS)/Program type (PTY) → Radio text → Radio text+ → Radio text+ title/Radio text+ artist → Frequency → Clock → Station name (PS)/Program type (PTY) with music synchronisation*2 → (back to the beginning)
CD or USB FRONT/ USB REAR/USB	(For CD-DA) Track title (Artist) → Track title (Disc name) → Track title (Date/Clock)*1 → Playing time (Date/Clock)*1 → Track title (Artist) with music synchronisation*2 → (back to the beginning)	(For CD-DA) Disc title/Artist → Track title/Artist → Playing time → Clock → Disc title/Artist with music synchronisation*2 → (back to the beginning)
	(For MP3/WMA/AAC/WAV/FLAC files) Song title (Artist) → Song title (Album name) → Song title (Date/Clock)*1 → File name (Folder name) → File name (Date/Clock)*1 → Playing time (Date/Clock)*1 → Song title (Artist) with music synchronisation*2 → (back to the beginning)	(For MP3/WMA/AAC/WAV/FLAC files) Song title/Artist → Album name/Artist → Folder name → File name → Playing time → Clock → Song title/Artist with music synchronisation*2 → (back to the beginning)
iPod FRONT/iPod REAR/ iPod USB/iPod BT or ANDROID FRONT/ ANDROID REAR/ANDROID	When [HEAD MODE]/[AUTO MODE] is selected (→ 9): Song title (Artist) → Song title (Album name) → Song title (Date/Clock)*1 → Playing time (Date/Clock)*1 → Song title (Artist) with music synchronisation*2 → (back to the beginning)	When [HEAD MODE]/[AUTO MODE] is selected (→ 9): Song title/Artist → Album name/Artist → Playing time → Clock → Song title/Artist with music synchronisation*2 → (back to the beginning)

*1, *2, : (→ 35)

REFERENCES



Source name	Display information	
	KD-R995BTS/KD-R990BTS/KD-R895BTS/KD-RD99BTS/KD-R99MBS	KD-R792BT/KD-R790BT/KD-RD79BT
PANDORA FRONT/ PANDORA REAR/PANDORA/ PANDORA BT	Station name (Date/Clock)*1 → Shared/Radio (Date/Clock)*1 → Song title (Artist) → Song title (Album name) → Song title (Date/Clock)*1 → Playing time (Date/Clock)*1 → Station name (Date) with music synchronisation*2 → (back to the beginning)	Station name → Shared/Radio → Song title → Artist name → Album name → Playing time → Clock → Station name with music synchronisation*2 → (back to the beginning)
IHEARTRADIO-F/ IHEARTRADIO-R/ IHEARTRADIO	Station name (Date/Clock)*1 → Song title (Artist) → Song title (Date/Clock)*1 → Station name (Date) with music synchronisation*2 → (back to the beginning)	Station name → Song title/Artist → Clock → Station name with music synchronisation*2 → (back to the beginning)
SPOTIFY FRONT/ SPOTIFY REAR/SPOTIFY/ SPOTIFY BT	Context title (Date/Clock)*1 → Song title (Artist) → Song title (Album name) → Song title (Date/Clock)*1 → Playing Time (Date/Clock)*1 → Context title (Date) with music synchronisation*2 → (back to the beginning)	Context title → Song title → Artist name → Album name → Playing Time → Clock → Context title with music synchronisation*2 → (back to the beginning)
SIRIUS XM	Channel number (Status) → Channel name (Status) → Artist (Status) → Song title (Status) → Content information (Status) → Category name (Status) → Date (Status) → Channel number (Status) with music synchronisation*2 → (back to the beginning)	—
BT AUDIO	Song title (Artist) → Song title (Album name) → Song title (Date/Clock)*1 → Playing time (Date/Clock)*1 → Song title (Artist) with music synchronisation*2 → (back to the beginning)	Song title/Artist → Album name/Artist → Playing time → Clock → Song title/Artist with music synchronisation*2 → (back to the beginning)
AUX	AUX (Date/Clock)*1 → AUX (Date) with music synchronisation*2 → (back to the beginning)	AUX → Clock → AUX with music synchronisation*2 → (back to the beginning)



*1 Battery and signal strength of the Bluetooth device will be shown if [BATT/SIGNAL] is set to [AUTO]. (→ 19)

*2 For KD-R995BTS/KD-R990BTS/ KD-R895BTS/KD-RD99BTS/KD-R99MBS: The color of the button illumination changes and synchronises with the music.

For KD-R792BT/KD-R790BT/KD-RD79BT: The brightness of the button illumination changes and synchronises with the music.

TROUBLESHOOTING

	Symptom	Remedy
General	Sound cannot be heard.	<ul style="list-style-type: none"> Adjust the volume to the optimum level. Check the cords and connections.
	"MISWIRING CHECK WIRING THEN PWR ON" appears.	Turn the power off, then check to be sure the terminals of the speaker wires are insulated properly. Turn the power on again.
	"PROTECTING SEND SERVICE" appears.	Send the unit to the nearest service center.
	Source cannot be selected.	Check the [SOURCE SELECT] setting. (➔ 4)
	"ERROR"/"FAIL" (For KD-R792BT)	Your steering remote controller is not compatible, learning may not be completed. Consult your car audio dealer for details.
Radio	<ul style="list-style-type: none"> Radio reception is poor. Static noise while listening to the radio. 	Connect the antenna firmly.
CD/USB/iPod	Disc cannot be ejected.	Press and hold  to forcibly eject the disc. Be careful not to drop the disc when it is ejected.
	"IN DISC" appears.	Make sure nothing is blocking the loading slot when you eject the disc.
	"PLEASE EJECT" appears.	Press  , then insert the disc correctly.
	Playback order is not as intended.	The playback order is determined by the file name (USB) or the order in which files were recorded (disc).
	Elapsed playing time is not correct.	This depends on the recording process earlier.
	"NOT SUPPORT" appears and track skips.	Check whether the track is a playable format. (➔ 32, 33)
	"READING" keeps flashing.	<ul style="list-style-type: none"> Do not use too many hierarchical levels and folders. Reload the disc or reattach the USB device.

	Symptom	Remedy	
CD/USB/iPod	"UNSUPPORTED DEVICE" appears.	<ul style="list-style-type: none"> Check whether the connected device is compatible with this unit and ensure the file systems are in supported formats. (➔ 32, 33) Reattach the device. 	
	"UNRESPONSIVE DEVICE" appears.	Make sure the device is not malfunction and reattach the device.	
	"USB HUB IS NOT SUPPORTED" appears.	This unit cannot support a USB device connected via a USB hub.	
	"CANNOT PLAY" appears.	Connect a USB device that contains playable audio files.	
	<ul style="list-style-type: none"> The source does not change to "USB" when you connect a USB device while listening to another source. "USB ERROR" appears 	<p>The USB port is drawing more power than the design limit. Turn the power off and unplug the USB device. Then, turn on the power and reattach the USB device. If this does not solve the problem, turn the power off and on (or reset the unit) before replacing with another USB device.</p>	
	The iPod/iPhone does not turn on or does not work.	<ul style="list-style-type: none"> Check the connection between this unit and iPod/iPhone. Disconnect and reset the iPod/iPhone using hard reset. 	
	"LOADING" appears when you enter search mode by pressing  /  .	This unit is still preparing the iPod/iPhone music list. It may take some time to load, try again later.	
	Correct characters are not displayed.	<ul style="list-style-type: none"> This unit can only display uppercase letters, numbers, and a limited number of symbols. Depending on the display language you have selected (➔ 5), some characters may not be displayed correctly. 	

TROUBLESHOOTING

	Symptom	Remedy
ANDROID	<ul style="list-style-type: none"> Sound cannot be heard during playback. Sound output only from the Android device. 	<ul style="list-style-type: none"> Reconnect the Android device. If in [AUDIO MODE], launch any media player application on the Android device and start playback. If in [AUDIO MODE], relaunch the current media player application or use another media player application. Restart the Android device. If this does not solve the problem, the connected Android device is unable to route the audio signal to unit. (➔ 33)
	Cannot playback at [AUTO MODE].	<ul style="list-style-type: none"> Make sure JVC MUSIC PLAY APP is installed on the Android device. (➔ 8) Reconnect the Android device and select the appropriate control mode. (➔ 9) If this does not solve the problem, the connected Android device does not support [AUTO MODE]. (➔ 33)
	"NO DEVICE" or "READING" keeps flashing.	<ul style="list-style-type: none"> Switch off the developer options on the Android device. Reconnect the Android device. If this does not solve the problem, the connected Android device does not support [AUTO MODE]. (➔ 33)
	Playback is intermittent or sound skips.	Turn off the power saving mode on the Android device.
	"CANNOT PLAY"	<ul style="list-style-type: none"> Make sure Android device contains playable audio files. Reconnect the Android device. Restart the Android device.
Pandora	"ADD ERROR"	New station creation is unsuccessful.
	"CHK DEVICE"	Check the Pandora application on your device.
	"NO SKIPS"	The skip limit has been reached.
	"NO STATIONS"	No stations are found.
	"STATION LMT"	The number of registered stations has reached its limit. Retry after deleting unnecessary stations from your device.

	Symptom	Remedy
Pandora	"UPGRADE APP"	Make sure you have installed the latest version of the Pandora application on your device.
	"CONNECT ERR"	Communication is unstable.
	"RATING ERR"	Registration of thumbs up/thumbs down has failed due to insufficient network connectivity.
	"THUMBS N/A"	Registration of thumbs up/thumbs down is not allowed.
iHeartRadio	"LICENSE ERR"	You try to access from a country which Pandora is not deliverable.
	Station cannot be selected.	If "Explicit Content" in [Account Settings] is checked in the web version of iHeartRADIO, custom stations become unavailable.
Spotify	"NOT CONNECTD"	Link to the application is impossible.
	"DISCONNECTED"	USB is disconnected from the head unit. Please make sure the device is connected properly through USB.
	"CONNECTING"	<ul style="list-style-type: none"> Connected via USB input terminal: The device is connecting to the head unit. Please wait. Connected via Bluetooth: The Bluetooth is disconnected. Please check Bluetooth connection and make sure both the device and unit are paired and connected.
	"CHECK APP"	The Spotify application is not connected properly or user is not login. End the Spotify application and restart. Then, log in to your Spotify account.
SiriusXM® Radio	"CH LOCKED LOCK CODE?"	The selected channel is locked. Enter the correct pass code to unlock. (➔ 15)
	"CHAN UNSUB"	The selected channel is unsubscribed.

TROUBLESHOOTING

	Symptom	Remedy
SiriusXM® Radio	"CH UNAVAIL"	The selected channel is unavailable.
	"CHECK ANTENNA"	Check that the antenna and its connection are in good condition.
	"CHECK TUNER"	Make sure the SiriusXM Vehicle Tuner is connected to the unit.
	"NO SIGNAL"	Make sure the antenna is mounted outside the vehicle.
	"SUBSCRIPTION UPDATED – PRESS ENTER TO CONTINUE."	Your subscription is updated. Press the volume knob to continue.
	"CODE ERROR"	Make sure you have entered the correct pass code. (➔ 15)
	"NO CONTENT"	There is insufficient content to start TuneScan.
	"SCAN CANCEL"	TuneScan has been aborted.
Bluetooth®	No Bluetooth device is detected.	<ul style="list-style-type: none"> Search from the Bluetooth device again. Reset the unit. (➔ 3)
	Pairing cannot be made.	<ul style="list-style-type: none"> Make sure you have entered the same PIN code to both the unit and Bluetooth device. Delete pairing information from both the unit and the Bluetooth device, then perform pairing again. (➔ 16)
	Echo or noise occurs.	<ul style="list-style-type: none"> Adjust the microphone unit's position. (➔ 16) Check the [ECHO CANCEL] setting. (➔ 18)
	Phone sound quality is poor.	<ul style="list-style-type: none"> Reduce the distance between the unit and the Bluetooth device. Move the car to a place where you can get a better signal reception.

	Symptom	Remedy
Bluetooth®	Sound is being interrupted or skipped during playback of a Bluetooth audio player.	<ul style="list-style-type: none"> Reduce the distance between the unit and the Bluetooth audio player. Turn off, then turn on the unit and try to connect again. Other Bluetooth devices might be trying to connect to the unit.
	The connected Bluetooth audio player cannot be controlled.	<ul style="list-style-type: none"> Check whether the connected Bluetooth audio player supports Audio/Video Remote Control Profile (AVRCP). (Refer to the instructions of your audio player.) Disconnect and connect the Bluetooth player again.
	"PLEASE WAIT"	The unit is preparing to use the Bluetooth function. If the message does not disappear, turn off and turn on the unit, then connect the device again.
	"NOT SUPPORT"	The connected phone does not support Voice Recognition feature.
	"ERROR"	Try the operation again. If "ERROR" appears again, check if the device supports the function you have tried.
	"H/W ERROR"	Reset the unit and try the operation again. If "H/W ERROR" appears again, consult your nearest service center.
	"SWITCHING NG"	The connected phones might not support phone switching feature.

If you have any troubles, try the following:

- 1 Check TROUBLESHOOTING
- 2 Reset the unit (➔ 3)

SPECIFICATIONS

Tuner	FM Frequency Range	87.9 MHz — 107.9 MHz (200 kHz step) 87.5 MHz — 108.0 MHz (50 kHz step)
	Usable Sensitivity (S/N = 26 dB)	8.2 dBf (0.71 μ V/75 Ω)
	Quieting Sensitivity (DIN S/N = 46 dB)	17.2 dBf (2.0 μ V/75 Ω)
	Frequency Response (± 3 dB)	30 Hz — 15 kHz
	Signal-to-Noise Ratio (MONO)	64 dB
	Stereo Separation (1 kHz)	40 dB
	AM Frequency Range	530 kHz — 1 700 kHz (10 kHz step) 531 kHz — 1 611 kHz (9 kHz step)
Usable Sensitivity (S/N = 20 dB)	29 dB μ (28.2 μ V)	

CD player	Laser Diode	GaAlAs
	Digital Filter (D/A)	8 times over sampling
	Spindle Speed	500 rpm — 200 rpm (CLV)
	Wow & Flutter	Below measurable limit
	Frequency Response (± 1 dB)	20 Hz — 20 kHz
	Total Harmonic Distortion (1 kHz)	0.01 %
	Signal-to-Noise Ratio (1 kHz)	105 dB
	Dynamic Range	90 dB
	Channel Separation	85 dB
	MP3 Decode	Compliant with MPEG-1/2 Audio Layer-3
WMA Decode	Compliant with Windows Media Audio	
AAC Decode	AAC-LC “.aac” files	

USB	USB Standard	USB 1.1, USB 2.0 (Full speed)
	Compatible Devices	Mass storage class
	File System	FAT12/16/32
	Maximum Supply Current	DC 5 V \leq 1.5 A
	Digital Filter (D/A) Converter	24 Bit
	Frequency Response (± 1 dB)	20 Hz — 20 kHz
	Signal-to-Noise Ratio (1 kHz)	105 dB
	Dynamic Range	90 dB
	Channel Separation	85 dB
	MP3 Decode	Compliant with MPEG-1/2 Audio Layer-3
WMA Decode	Compliant with Windows Media Audio	
AAC Decode	AAC-LC “.aac”, “.m4a” files	
WAV Decode	Linear-PCM	
FLAC Decode	FLAC file, up to 24 bit/96 kHz	

Auxiliary	Frequency Response (± 3 dB)	20 Hz — 20 kHz
	Input Maximum Voltage	1 000 mV
	Input Impedance	30 k Ω

Bluetooth	Version	Bluetooth 3.0
	Frequency Range	2.402 GHz — 2.480 GHz
	Output Power	+4 dBm (MAX), 0 dBm (AVE) Power Class 2
	Maximum Communication Range	Line of sight approx. 10 m (32.8 ft)
	Pairing	SSP (Secure Simple Pairing)
	Profile	HFP1.6 (Hands-Free Profile) A2DP (Advanced Audio Distribution Profile) AVRCP1.5 (Audio/Video Remote Control Profile) PBAP (Phonebook Access Profile) SPP (Serial Port Profile)

SPECIFICATIONS

Audio	Maximum Output Power	50 W × 4 or 50 W × 2 + 50 W × 1 (Subwoofer = 4 Ω)
	Full Bandwidth Power (at less than 1 % THD)	22 W × 4
	Speaker Impedance	4 Ω — 8 Ω
	Preout Level/Load (CD/USB)	KD-R995BTS: 5 000 mV/10 kΩ load KD-R895BTS/KD-R99MBS: 4 000 mV/10 kΩ load KD-R990BTS/KD-R792BT/KD-R790BT/ KD-RD99BTS/KD-RD79BT: 2 500 mV/10 kΩ load
	Preout Impedance	≤ 600 Ω
General	Operating Voltage (10.5 V — 16 V allowable)	14.4 V
	Maximum Current Consumption	10 A
	Operating Temperature Range	-10°C — +60°C
	Installation Size (W × H × D)	182 mm × 53 mm × 158 mm (7-3/16" × 2-1/8" × 6-1/4")
	Net Weight (includes Trimplate, Mounting Sleeve)	1.2 kg (2.7 lbs)

Subject to change without notice.

INSTALLATION/CONNECTION

▲ Warning

- The unit can only be used with a 12 V DC power supply, negative ground.
- Disconnect the battery's negative terminal before wiring and mounting.
- Do not connect Battery wire (yellow) and Ignition wire (red) to the car chassis or Ground wire (black) to prevent a short circuit.
- To prevent short circuit:
 - Insulate unconnected wires with vinyl tape.
 - Be sure to ground this unit to the car's chassis again after installation.
 - Secure the wires with cable clamps and wrap vinyl tape around the wires that comes into contact with metal parts to protect the wires.

▲ Caution

- For safety's sake, leave wiring and mounting to professionals. Consult the car audio dealer.
- Install this unit in the console of your vehicle. Do not touch the metal parts of this unit during and shortly after use of the unit. Metal parts such as the heat sink and enclosure become hot.
- Do not connect the ⊖ wires of speakers to the car chassis or Ground wire (black), or connect them in parallel.
- Connect speakers with a maximum power of more than 50 W. If the maximum power of the speakers is lower than 50 W, change the [AMP GAIN] setting to avoid damaging the speakers. (➔ 25)
- Mount the unit at an angle of less than 30°.
- If your vehicle wiring harness does not have the ignition terminal, connect Ignition wire (red) to the terminal on the vehicle's fuse box which provides 12 V DC power supply and is turned on and off by the ignition key.
- Keep all cables away from heat dissipate metal parts.
- After the unit is installed, check whether the brake lamps, blinkers, wipers, etc. on the car are working properly.
- If the fuse blows, first make sure the wires are not touching car's chassis, then replace the old fuse with one that has the same rating.

INSTALLATION/CONNECTION

Part list for installation

(A) Faceplate

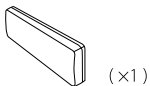

(×1)

(B) Trim plate



(×1)

(C) Mounting sleeve

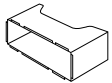

(×1)

(D) Wiring harness

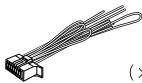

(×1)

(E) Extraction key

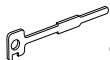

(×2)

Basic procedure

- 1 Remove the key from the ignition switch, then disconnect the \ominus terminal of the car battery.
- 2 Connect the wires properly.
See Wiring connection. (→ 42)
- 3 Install the unit to your car.
See Installing the unit (in-dash mounting).
- 4 Connect the \ominus terminal of the car battery.
- 5 Press **SRC** to turn on the power.
- 6 Detach the faceplate and reset the unit within 5 seconds.
(→ 3)

Installing the unit (in-dash mounting)

1

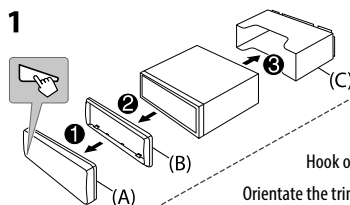

2

Hook on the top side
Orientate the trim plate as illustrated before fitting.

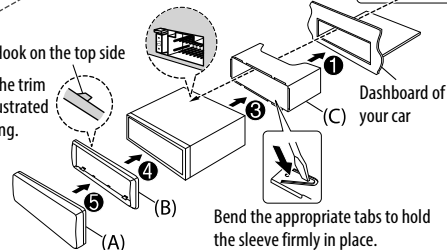

When installing without the mounting sleeve

- 1 Remove the mounting sleeve and trim plate from the unit.
- 2 Align the holes in the unit (on both sides) with the vehicle mounting bracket and secure the unit with screws (commercially available).

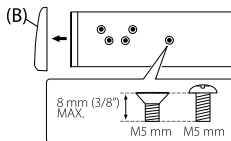

⚠ Use only the specified screws. Using wrong screws might damage the unit.

How to remove the unit

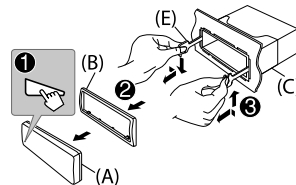

INSTALLATION/CONNECTION

Wiring connection

IMPORTANT

We recommend installing the unit with a commercially available custom wiring harness specific for your car and leave this job to professionals for your safety. Consult your car audio dealer.

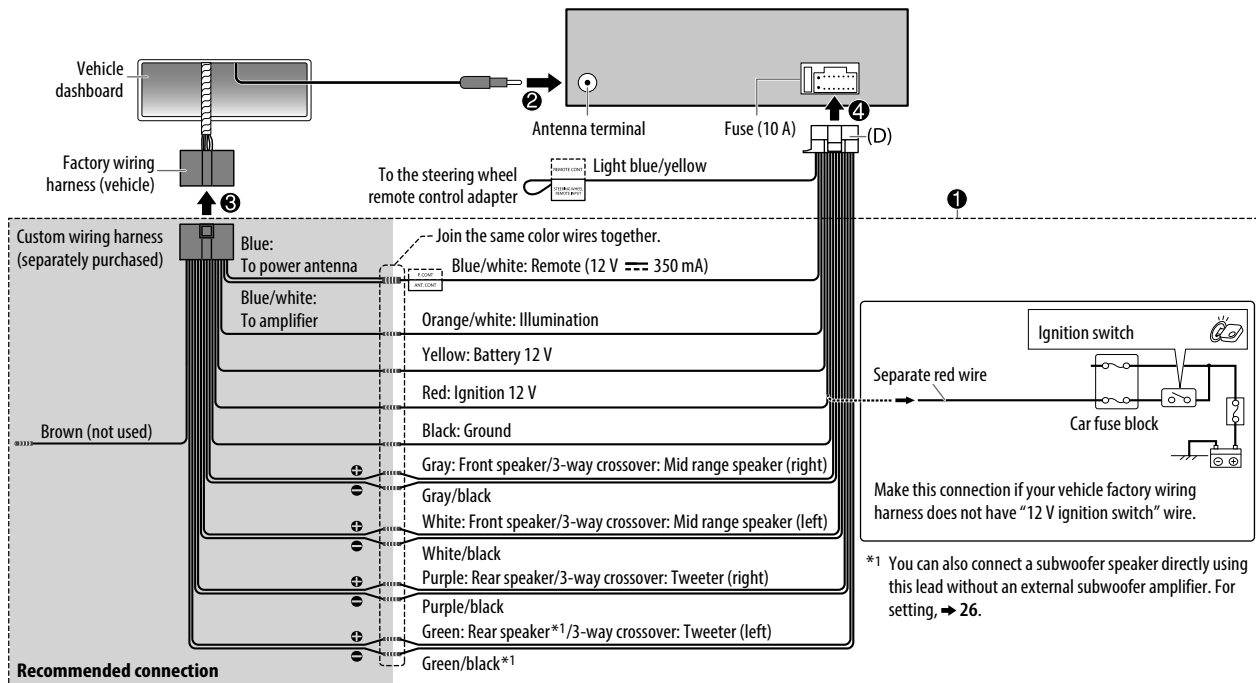

INSTALLATION/CONNECTION

Connecting external components

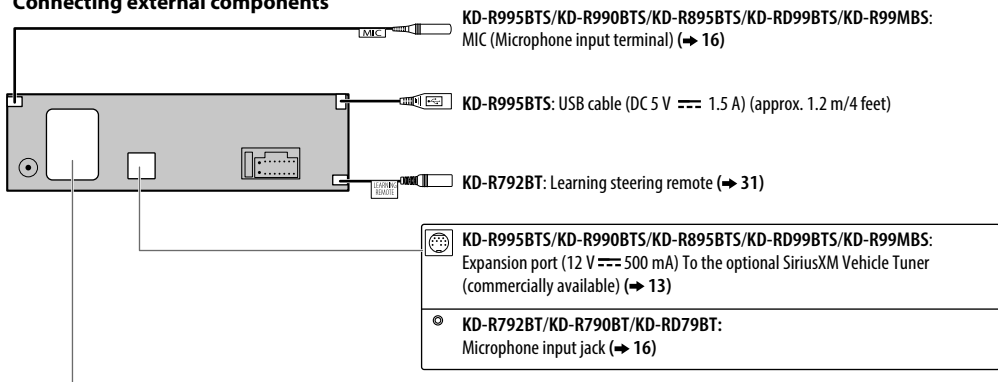

Connecting external amplifiers

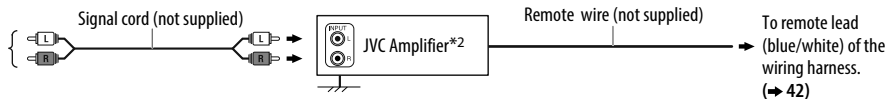
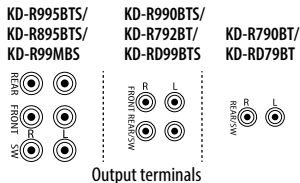

Output terminals	2-way crossover setting	3-way crossover setting
REAR	: Rear output	Tweeter output
FRONT	: Front output	Mid Range output
SW	: Subwoofer output	Woofer output
FRONT	: Front output	Mid Range output
REAR/SW	: Rear/subwoofer output	Woofer output
REAR/SW	: Rear/subwoofer output	Woofer output

*2 Firmly connect the ground wire of the amplifier to the car's chassis to avoid damaging the unit.